

# LINKSYS®

A Division of Cisco Systems, Inc.

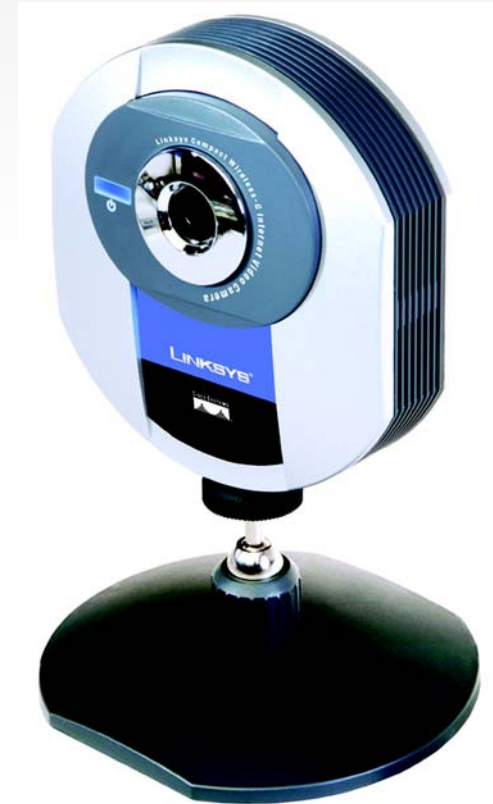

2.4GHz  
802.11g Compact  
**Wireless-G**

Internet Video Camera **User Guide**



Model No. **WVC54GC**



## Copyright and Trademarks

Specifications are subject to change without notice. Linksys is a registered trademark or trademark of Cisco Systems, Inc. and/or its affiliates in the U.S. and certain other countries. Copyright © 2005 Cisco Systems, Inc. All rights reserved. Other brands and product names are trademarks or registered trademarks of their respective holders.

**WARNING:** This product contains chemicals, including lead, known to the State of California to cause cancer, and birth defects or other reproductive harm. ***Wash hands after handling.***

## How to Use this User Guide

The user guide to the Compact Wireless-G Internet Video Camera has been designed to make understanding networking with the Access Point easier than ever. Look for the following items when reading this User Guide:



This checkmark means there is a note of interest and is something you should pay special attention to while using the Camera.



This exclamation point means there is a caution or warning and is something that could damage your property or the Camera.



This question mark provides you with a reminder about something you might need to do while using the Camera.

In addition to these symbols, there are definitions for technical terms that are presented like this:

***word: definition.***

Also, each figure (diagram, screenshot, or other image) is provided with a figure number and description, like this:

**Figure 0-1: Sample Figure Description**

Figure numbers and descriptions can also be found in the “List of Figures” section.

# Table of Contents

<b>Chapter 1: Introduction</b>	<b>1</b>
Welcome	1
What's in this Guide?	2
<b>Chapter 2: Planning Your Wireless Network</b>	<b>4</b>
Introduction	4
Ad-Hoc and Infrastructure Modes	4
Network Layout	4
<b>Chapter 3: Getting to Know the Compact Wireless-G Internet Video Camera</b>	<b>6</b>
Camera LED	6
Camera Head	6
Camera Reset Button	6
Camera Ports	7
Camera Stand	7
<b>Chapter 4: Connecting the Compact Wireless-G Internet Video Camera for Setup</b>	<b>8</b>
Overview	8
Connection to a Wired Network for Setup	8
Moving the Camera to a Different Network	9
<b>Chapter 5: Setting up and Mounting the Compact Wireless-G Internet Video Camera</b>	<b>10</b>
Setup Wizard	10
Placement Options	19
<b>Chapter 6: Installing and Using the Compact Wireless-G Internet Video Camera Multi-Camera Viewer &amp; Recorder Utility</b>	<b>21</b>
Overview	21
Installing the Multi-Camera Viewer & Recorder Utility	21
Using the Multi-Camera Viewer & Recorder Utility	23
<b>Chapter 7: Setting up the Linksys SoloLink™ DDNS Service</b>	<b>33</b>
Overview	33
Introduction	33

Setup Wizard for the SoloLink DDNS Service	33
SoloLink Registration of Additional Cameras	43
<b>Chapter 8: Using the Compact Wireless-G Internet Video Camera's</b>	
<b>Web-based Utility</b>	<b>45</b>
Overview	45
How to Access the Web-based Utility	45
View Video	46
Setup	47
Help	60
<b>Appendix A: Troubleshooting</b>	<b>61</b>
Common Problems and Solutions	61
Frequently Asked Questions	63
<b>Appendix B: Wireless Security</b>	<b>66</b>
Security Precautions	66
Security Threats Facing Wireless Networks	66
<b>Appendix C: Upgrading Firmware</b>	<b>69</b>
<b>Appendix D: Windows Help</b>	<b>70</b>
<b>Appendix E: Glossary</b>	<b>71</b>
<b>Appendix F: Specifications</b>	<b>77</b>
<b>Appendix G: Warranty Information</b>	<b>79</b>
<b>Appendix H: Regulatory Information</b>	<b>80</b>
<b>Appendix I: Contact Information</b>	<b>84</b>

# List of Figures

Figure 3-1: Camera LED	6
Figure 3-2: Camera Tilting Feature	6
Figure 3-3: Reset Button	6
Figure 3-4: Camera in Standing Position	7
Figure 3-5: Camera in Wall-Mounting Position	7
Figure 4-1: Connect the Ethernet Network Cable	8
Figure 4-2: Connect the Power Adapter	8
Figure 5-1: Setup Wizard - Welcome Screen	10
Figure 5-2: End User License Agreement Screen	10
Figure 5-3: Connect the Network Cable to the Router or Switch Screen	11
Figure 5-4: Connect the Network Cable to the Camera Screen	11
Figure 5-5: Power on the Camera Screen	12
Figure 5-6: Check the LED Screen	12
Figure 5-7: Cameras Found Screen	13
Figure 5-8: Login Screen	13
Figure 5-9: Basic Settings Screen	13
Figure 5-10: Network Settings Screen	14
Figure 5-11: IP Settings Screen	14
Figure 5-12: Mode Settings Screen	15
Figure 5-13: Wireless Settings Screen	15
Figure 5-14: Security Settings - WPA-Personal Screen	16
Figure 5-15: Security Settings - WEP (64-Bit) Screen	16
Figure 5-16: Review New Settings Screen	17
Figure 5-17: Confirm New Settings Screen	17
Figure 5-18: Congratulations Screen	18
Figure 5-19: Stand Option	19
Figure 5-20: Camera in Standing Position	19
Figure 5-21: Wall Mount Option	20

Figure 5-22: Camera in Wall-Mounting Position	20
Figure 5-23: Wall-Mount Slots	20
Figure 6-1: Install Viewer & Recorder Utility Screen	21
Figure 6-2: Install Viewer & Recorder Utility - Welcome Screen	21
Figure 6-3: Choose Destination Location Screen	22
Figure 6-4: Ready to Install the Program Screen	22
Figure 6-5: InstallShield Wizard Complete Screen	22
Figure 6-6: Multi-Camera Viewer & Recorder Utility Icon	23
Figure 6-7: Main Screen	23
Figure 6-8: Add Camera - LAN Screen	24
Figure 6-9: Add Camera - Internet Screen	25
Figure 6-10: View Video Screen	26
Figure 6-11: Delete Camera Screen	27
Figure 6-12: Change Settings Screen	27
Figure 6-13: Scheduled Recordings Screen	28
Figure 6-14: Files Screen	29
Figure 6-15: Recorded Files Screen	29
Figure 6-16: Motion Detection Files Screen	29
Figure 6-17: Window Showing SnapShot Folders	30
Figure 6-18: Motion Detection Settings Screen	30
Figure 6-19: Utility Settings Screen	31
Figure 7-1: SoloLink Service	33
Figure 7-2: SoloLink Welcome Screen	33
Figure 7-3: SoloLink for Dynamic IP Address Screen	34
Figure 7-4: SoloLink for Convenience Screen	34
Figure 7-5: Check Connections Screen	35
Figure 7-6: Cameras Found Screen	35
Figure 7-7: Login Screen	36
Figure 7-8: SoloLink DDNS Screen	36
Figure 7-9: Confirm Active Internet Connection Screen	37

Figure 7-10: Welcome to the SoloLink DDNS Service Screen	37
Figure 7-11: Sign Up Screen	38
Figure 7-12: Confirmation of New Settings Screen	39
Figure 7-13: Select a Location ID Screen	39
Figure 7-14: Confirm Your Location ID Screen	40
Figure 7-15: Payment Screen	40
Figure 7-16: Verification Screen	40
Figure 7-17: Create Links Screen	41
Figure 7-18: Successful Registration Screen	41
Figure 7-19: Account Confirmation of Camera Screen	42
Figure 7-20: Successful Setup Screen	42
Figure 7-21: Port Forwarding Information	43
Figure 7-22: Web-based Utility Welcome	43
Figure 7-23: Web Utility Login Screen	43
Figure 7-24: SoloLink DDNS Screen	44
Figure 7-25: Find Available Port Screen	44
Figure 8-1: Camera's Default IP Address	45
Figure 8-2: Web-based Utility Welcome	45
Figure 8-3: Security Warning Screen	46
Figure 8-4: View Video Screen	46
Figure 8-5: Web Utility Login Screen	47
Figure 8-6: Basic Screen	47
Figure 8-7: Basic - Device Settings Screen	48
Figure 8-8: Basic - LAN and Wireless Settings Screen	48
Figure 8-9: Wireless Security - WPA Personal Screen	49
Figure 8-10: Wireless Security - WEP Screen	49
Figure 8-11: Image Screen	50
Figure 8-12: Administrator Screen	52
Figure 8-13: Upgrade Firmware Screen	52
Figure 8-14: Users Screen	53

Figure 8-15: SoloLink DDNS Screen	54
Figure 8-16: New User Registration Screen	54
Figure 8-17: Password Request Screen	54
Figure 8-18: SoloLink Screen, continued	55
Figure 8-19: Manage Your SoloLink DDNS Account	55
Figure 8-20: Device Removal Screen	55
Figure 8-21: Find Available Port Screen	56
Figure 8-22: Options Screen	57
Figure 8-23: Options Screen, continued	57
Figure 8-24: Motion Detection Screen	57
Figure 8-25: Status Screen	59
Figure 8-26: User Help Screen	60
Figure 8-27: Administrator Help Screen	60
Figure C-1: Upgrade Firmware Screen	69



# Chapter 1: Introduction

## Welcome

Thank you for choosing the Linksys Compact Wireless-G Internet Video Camera. This Camera sends live video through the Internet to a web browser anywhere in the world! This compact, self-contained unit lets you keep an eye on your home, your kids, your workplace—whatever’s important to you.

How does the Camera do all of this? Unlike standard “web cams” that require an attached PC, the Internet Video Camera contains its own web server, so it can connect directly to a network, either over Wireless-G (802.11b) networking, or over 10/100 Ethernet cable. The advanced MPEG-4 video compression produces a high-quality, high-framerate, up to 320 x 240 audio/video stream.

The Internet Video Camera’s unique form-factor and wireless connectivity allows you to mount it on a wall nearly anywhere, or slip it into its included stand for desktop use. Once it’s connected to your home network, you can “see what it sees” from any PC in the house, while the audio/video stream is secured from the outside world, hidden behind your Router. If you want the video to be visible from outside your home network, you can open an appropriate port on the Router, and then create password-protected accounts to manage access to the Camera, or leave it wide open for the world to see. The SoloLink DDNS Service (trial sign-up included) lets you access your Camera using an easy-to-remember “name”, even if your home Internet connection uses a dynamic IP address.

You can also turn on Security Mode, which tells the Camera to send you an e-mail message with a short video attached to up to three e-mail addresses whenever it detects motion in its field of view. You can then log onto the live video stream if the situation warrants. The included Multi-Camera Viewer & Recorder Utility lets you record the video stream to your local hard drive, “live” or on a predetermined schedule.

Use the instructions in this Guide to help you integrate the Camera into your network. These instructions should be all you need to get the most out of the Compact Wireless-G Internet Video Camera.

**802.11g:** An IEEE wireless networking standard that specifies a maximum data transfer rate of 54Mbps, an operating frequency of 2.4GHz, and backward compatibility with 802.11b devices.

**Ethernet:** an IEEE standard network protocol that specifies how data is placed on and retrieved from a common transmission medium.

## What's in this Guide?

This user guide covers the steps for setting up and using the Compact Wireless-G Internet Video Camera.

- **Chapter 1: Introduction**  
This chapter describes the Camera's applications and this User Guide.
- **Chapter 2: Planning Your Wireless Network**  
This chapter discusses a few of the basics about wireless networking.
- **Chapter 3: Getting to Know the Compact Wireless-G Internet Video Camera**  
This chapter describes the physical features of the Camera.
- **Chapter 4: Connecting the Compact Wireless-G Internet Video Camera**  
This chapter instructs you on how to connect the Camera to your network before you run the Setup Wizard.
- **Chapter 5: Setting up and Mounting the Compact Wireless-G Internet Video Camera**  
This chapter instructs you on how to use the Setup Wizard for setup and configuration of the Camera, as well as how to mount the Camera.
- **Chapter 6: Installing and Using the Compact Wireless-G Internet Video Camera Utility**  
This chapter explains how to install and use the Compact Wireless-G Internet Video Camera Utility on your PC, so you can view and record video.
- **Chapter 7: Setting up the Linksys SoloLink™ DDNS Service**  
This chapter discusses the advantages of the SoloLink DDNS Service and walks you through the setup procedure.
- **Chapter 8: Using the Compact Wireless-G Internet Video Camera Web-based Utility**  
This chapter describes the Web-based Utility and the features available, so you can use and alter advanced configuration settings.
- **Appendix A: Troubleshooting**  
This appendix describes some problems and solutions, as well as frequently asked questions, regarding installation and use of the Camera.
- **Appendix B: Wireless Security**  
This appendix discusses security issues regarding wireless networking and measures you can take to help protect your wireless network.

## Compact Wireless-G Internet Video Camera

- **Appendix C: Upgrading Firmware**  
This appendix explains how you can upgrade the Camera's firmware.
- **Appendix D: Windows Help**  
This appendix describes how you can use Windows Help for instructions about networking, such as installing the TCP/IP protocol.
- **Appendix E: Glossary**  
This appendix gives a brief glossary of terms frequently used in networking.
- **Appendix F: Specifications**  
This appendix provides the technical specifications for the Camera.
- **Appendix G: Warranty Information**  
This appendix supplies the warranty information for the Camera.
- **Appendix H: Regulatory Information**  
This appendix supplies the regulatory information regarding the Camera.
- **Appendix I: Contact Information**  
This appendix provides contact information for a variety of Linksys resources, including Technical Support.

# Chapter 2: Planning Your Wireless Network

## Introduction

A wireless local area network (WLAN) is exactly like a regular local area network (LAN), except that each computer in the WLAN uses a wireless device to connect to the network. Computers and other devices, such as peripherals, in a WLAN share the same frequency channel and SSID, which is an identification name for wireless devices.

## Ad-Hoc and Infrastructure Modes

Unlike wired networks, wireless networks have two different modes in which they may be set up: infrastructure and ad-hoc. An infrastructure configuration is a WLAN and wired LAN communicating to each other through an access point. An ad-hoc configuration is wireless-equipped computers communicating directly with each other. Choosing between these two modes depends on whether or not the wireless network needs to share data or peripherals with a wired network or not.

If the computers on the wireless network need to be accessed by a wired network or need to share a peripheral, such as a printer, with the wired network computers, the wireless network should be set up in infrastructure mode. The basis of infrastructure mode centers around an access point, which serves as the main point of communications in a wireless network. (A wireless router can also be used because a wireless router incorporates the capabilities of an access point.) Access points transmit data to PCs equipped with wireless network cards, which can roam within a certain radial range of the access point. Multiple access points can be arranged to work in succession to extend the roaming range, and can be set up to communicate with your Ethernet (wired) hardware as well.

If the wireless network is relatively small and needs to share resources only with the other computers on the wireless network, then the ad-hoc mode can be used. Ad-hoc mode allows computers equipped with wireless transmitters and receivers to communicate directly with each other, eliminating the need for an access point. The drawback of this mode is that, in Ad-Hoc mode, wireless-equipped computers are not able to communicate with computers on a wired network. And, of course, communication between the wireless-equipped computers is limited by the distance and interference directly between them.

## Network Layout

The Compact Wireless-G Internet Video Camera is compatible with all 802.11b and 802.11g routers, as well as access points. The Camera will also communicate with network adapters, such as the Wireless-B and Wireless-G

**LAN (Local Area Network):** the computers and networking products that make up the network in your home or office.

**WLAN (Wireless Local Area Network):** A group of computers and associated devices that communicate with each other wirelessly.

**Infrastructure:** configuration in which a wireless network is bridged to a wired network via an access point.

**Ad-hoc:** a group of wireless devices communicating directly to each other (peer-to-peer) without the use of an access point.

### Compact Wireless-G Internet Video Camera

Notebook Adapters for your laptop computers, Wireless-B and Wireless-G PCI Adapters for your desktop PCs, and Wireless-B and Wireless-G USB Adapters for your computers when you want to enjoy USB connectivity.

With these, and many other Linksys products, your networking options are limitless. Go to the Linksys website at [www.linksys.com](http://www.linksys.com) for more information about products that work with the Compact Wireless-G Internet Video Camera.

# Chapter 3: Getting to Know the Compact Wireless-G Internet Video Camera

## Camera LED

The Camera has one LEDs to let you know how the Camera is functioning.

**(power)** Blue. The LED lights up when the Camera is powered on. It flashes while the Camera is booting up and is solidly lit when the Camera is ready for use.

## Camera Head

The Camera head can be attached to its stand either on its bottom panel or its back panel. After the Camera has been assembled, you can tilt the Camera head from its ball joint.

## Camera Reset Button

The Camera features a Reset button on its bottom panel.

**RESET** The **RESET** button is what you will press if you need to reset the Camera. Insert a paper clip into the opening. Then press the button and hold it in for five seconds.



**IMPORTANT:** Resetting the Camera will erase all of your settings, such as encryption information, and replace them with the factory defaults. Do not reset the Camera if you want to retain these settings.



**NOTE:** These are the factory default settings of the Camera.  
default IP address: **192.168.1.115**  
user name: **admin**  
password: **admin**

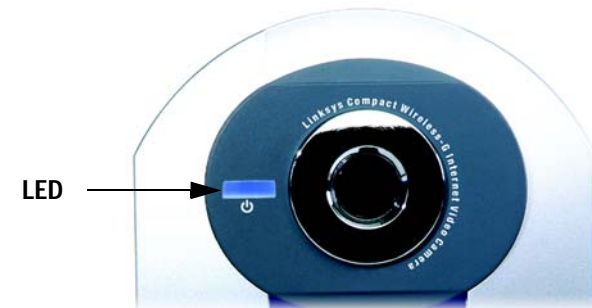

Figure 3-1: Camera LED



Figure 3-2: Camera Tilting Feature



Figure 3-3: Reset Button

## Camera Ports

The Camera features two ports on its back panel.

**POWER** The **POWER** port is where you will connect the power adapter.

**ETHERNET** The **ETHERNET** port is where you will connect the Ethernet network cable.

## Camera Stand

The Camera can stand on a surface or be mounted on a wall. Depending on the positioning you want, you can attach the Camera head to its stand at two different points.

If you want to stand the Camera on a surface, insert the screw end of the stand into the hole on the bottom panel. Tighten the screw end and then the gray thumbscrew.

If you want to mount the Camera on a wall, insert the screw end of the stand into the hole on the back panel. Tighten the screw end, and then tighten the gray thumbscrew. Refer to “Chapter 5: Setting Up and Mounting the Compact Wireless-G Internet Video Camera” for further instructions about mounting the Camera on a wall.

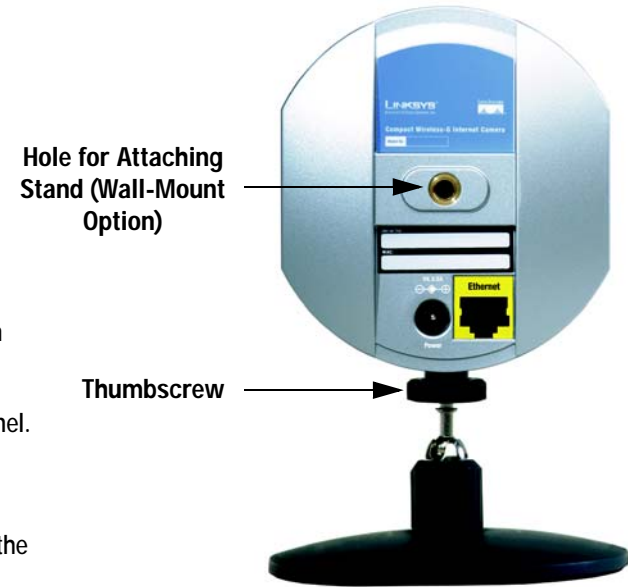

Figure 3-4: Camera in Standing Position



Figure 3-5: Camera in Wall-Mounting Position

# Chapter 4: Connecting the Compact Wireless-G Internet Video Camera for Setup

## Overview

Before you set up the Camera, connect it to your wired network.

If you need to move the Camera from a wired network to a wireless network, or vice versa, go to this section, "Moving the Camera to a Different Network."

## Connection to a Wired Network for Setup

1. Connect the Ethernet network cable to your router, switch, or computer.
2. Connect the other end of the cable to the Ethernet port on the Camera.
3. Connect the power adapter to the Power port on the Camera.
4. Plug the power adapter into an electrical outlet.

The Camera's power LED flashes while the Camera is initializing. The Camera is ready for use when the LED is solidly lit.

Proceed to "Chapter 5: Setting up and Mounting the Compact Wireless-G Internet Video Camera."



Figure 4-1: Connect the Ethernet Network Cable



**NOTE:** You MUST connect the Camera to a PC, router, or switch using the Ethernet network cable BEFORE powering on the Camera. Otherwise, the Camera will not function.



Figure 4-2: Connect the Power Adapter



## Moving the Camera to a Different Network

When you move the Camera from a wired network to a wireless network, or vice versa, you must power off the Camera before connecting to the new network. Proceed to the appropriate instructions.

To move the Camera from a wired network to a wireless network, follow these instructions:

1. Unplug the power adapter from the Camera.
2. Unplug the Ethernet network cable from the Camera.
3. Re-connect the power adapter to the Power port on the Camera.

The Camera's power LED flashes while the Camera is initializing. The Camera is ready for use when the LED is solidly lit.

**Proceed to "Chapter 5: Setting up and Mounting the Compact Wireless-G Internet Video Camera."**

To move the Camera from a wireless network to a wired network, follow these instructions:

1. Unplug the power adapter from the Camera.
2. Connect the Ethernet network cable to your PC, router, or switch.
3. Connect the other end of the cable to the Ethernet port on the Camera.
4. Re-connect the power adapter to the Power port on the Camera.

The Camera's power LED flashes while the Camera is initializing. The Camera is ready for use when the LED is solidly lit.

**Proceed to "Chapter 5: Setting up and Mounting the Compact Wireless-G Internet Video Camera."**

# Chapter 5: Setting up and Mounting the Compact Wireless-G Internet Video Camera

## Setup Wizard

The Compact Wireless-G Internet Video Camera Setup Wizard will guide you through the installation and configuration procedure.

1. Insert the Setup CD-ROM into your CD-ROM drive. The Setup Wizard should run automatically, and the *Welcome* screen should appear. If it does not, click the **Start** button and choose **Run**. In the field provided, enter `D:\wvc54gc.exe` (if "D" is the letter of your CD-ROM drive).

**Setup.** Click the **Setup** button to begin the installation process.

**Install Viewer & Recorder Utility.** To install the Camera's Multi-Camera Viewer & Recorder Utility on your PC, click this button.

**Setup SoloLink DDNS Service.** Click the **Setup SoloLink DDNS Service** button to configure and use Linksys's Dynamic Domain Name System (DDNS) service.

**User Guide.** Click this button to open the PDF file of this User Guide.

**Exit.** Click the **Exit** button to exit the Setup Wizard.

2. To install the Camera, click the **Setup** button on the *Welcome* screen.
3. After reading the License Agreement, click **Next** if you agree and want to continue the installation, or click **Cancel** to end the installation.



Figure 5-1: Setup Wizard - Welcome Screen

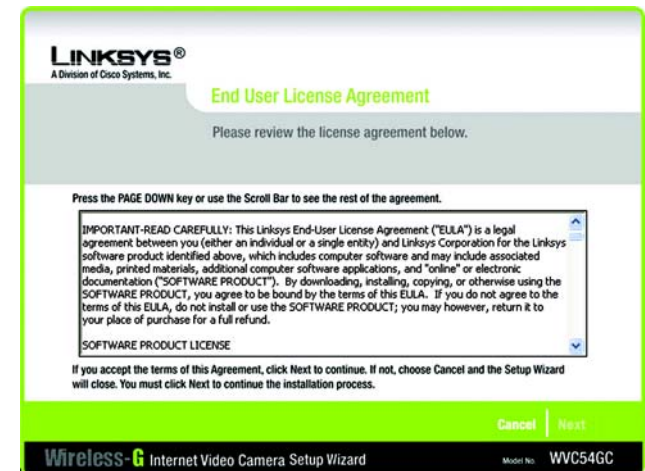

Figure 5-2: End User License Agreement Screen

4. Connect the included network cable to your network router or switch. Click the **Next** button.

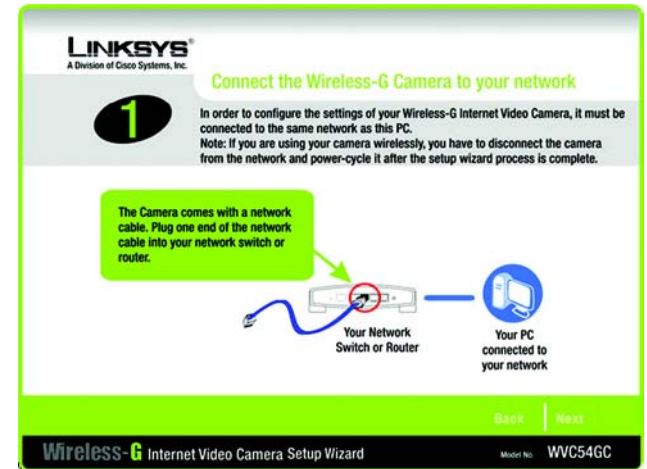

Figure 5-3: Connect the Network Cable to the Router or Switch Screen

5. Connect the other end of the network cable to the Camera's ETHERNET port. Click the **Next** button.

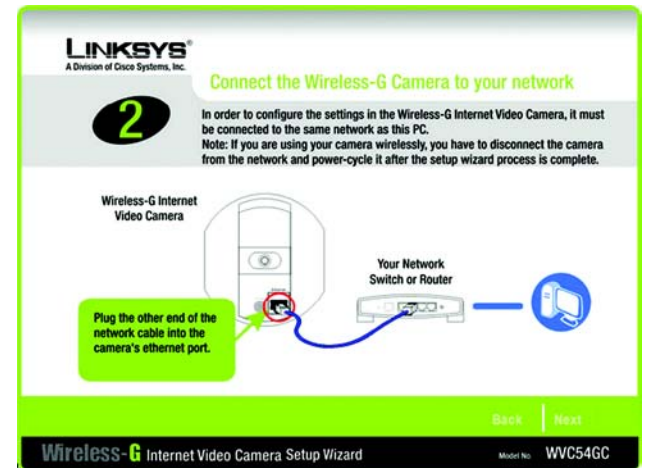

Figure 5-4: Connect the Network Cable to the Camera Screen

## Compact Wireless-G Internet Video Camera

6. Plug the included power adapter into the Camera's Power port. Plug the other end into an electrical outlet. Click the **Next** button.



Figure 5-5: Power on the Camera Screen

7. Make sure the LED is lit on the Camera's front panel. If it is not lit, make sure the cables are properly connected to the Camera. Click the **Next** button.

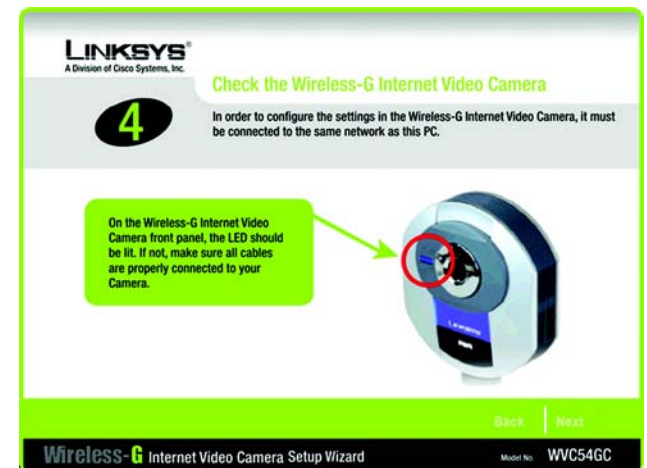

Figure 5-6: Check the LED Screen

## Compact Wireless-G Internet Video Camera

- The screen displays a list of Compact Wireless-G Internet Video Cameras on your network, along with the status information for the Camera whose name is highlighted. If the Camera you want is not displayed, click the **Search Again** button to run a new search for Cameras. In the *Selection* box, click the name of the Camera you are currently installing. Write down the IP address of the Camera, so you can use it to access the Web-based Utility later. Click the **Next** button.



Figure 5-7: Cameras Found Screen

- For security purposes, you will be asked to enter a name and password in order to have administrator access to the Camera. In lowercase letters, enter **admin** in the *Administrator Name* and *Administrator Password* fields (later you can change these through the Web-based Utility). Then click the **OK** button.



Figure 5-8: Login Screen

- On the *Basic Settings* screen, you can alter the following settings:

**Camera Name.** You can give the Camera a unique name. Memorable names are helpful, especially if you are using multiple Cameras on the same network. It should have 15 characters or fewer.

**Description.** You may enter additional information, such as location, in this field. It has a maximum length of 32 characters.

**Time Zone.** Select the time zone for the Camera's location.

**Date.** Enter today's date in the fields provided.

**Time.** Enter the current time in the fields provided.

When you have finished making your changes, click the **Next** button.

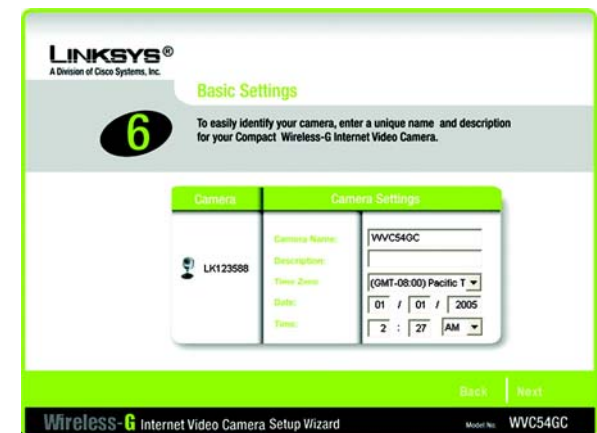

Figure 5-9: Basic Settings Screen

11. The Network Settings screen will appear. Select the setting appropriate for your network.

**Automatic Configuration-DHCP.** If your network has a DHCP server, such as a router with DHCP enabled, click the **Automatic Configuration-DHCP** radio button.

**Static IP address.** If you need to assign a static IP address to the Camera, keep the default setting, **Static IP address**.

Then click the **Next** button.

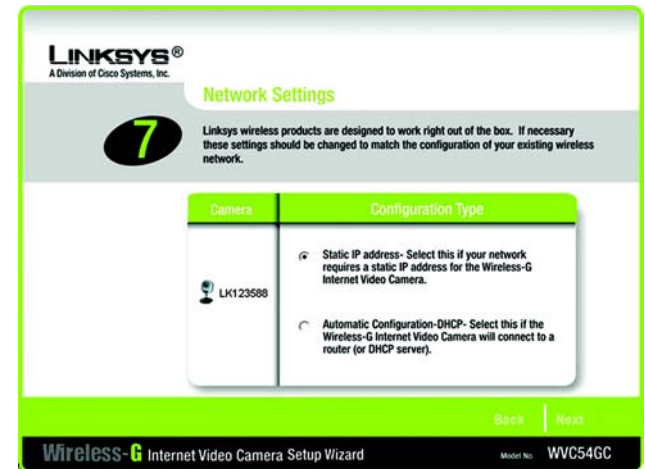

Figure 5-10: Network Settings Screen

12. If you selected Automatic Configuration-DHCP in step 12, then proceed to step 14.

If you selected Static IP Address, then the *IP Settings* screen will appear. Enter an IP Address, Subnet Mask, and Default Gateway appropriate for your network. You must specify an IP Address and Subnet Mask on this screen. If you are unsure about the Default Gateway, it is better to leave this field blank. Then complete the *Primary DNS* and/or *Secondary DNS* fields. Click the **Next** button.

**IP Address.** Enter the IP Address of the Camera.

**Subnet Mask.** Enter the Subnet Mask of the Camera.

**Default Gateway.** Enter the IP address of the Default Gateway. If you are not sure, leave this field blank.

**Primary and Secondary DNS.** Enter the IP address of your primary and secondary DNS server. You must enter at least one DNS address, which can be obtained from your ISP.

When you have finished making your changes, click the **Next** button.

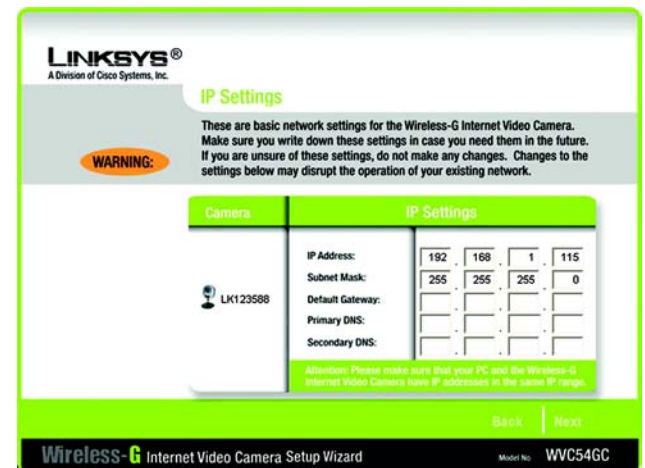

Figure 5-11: IP Settings Screen

13. The *Mode Setting* screen will appear. Select the appropriate mode for your network.

**Infrastructure.** Click the **Infrastructure** radio button if you want the Camera to communicate using an access point or wireless router.

**Ad-Hoc.** Click the **Ad-Hoc** radio button if you want the Camera to communicate without using an access point or wireless router. Click the **Next** button.

14. The *Wireless Settings* screen will appear, so you can change the wireless settings. Enter your wireless network's SSID or network name. If you chose Ad-Hoc mode, select the channel at which the network broadcasts its wireless signal.

**SSID.** The SSID must be identical for all devices in a wireless network. It is case-sensitive and should have 32 alphanumeric characters or fewer. (You can use any keyboard character, but do not use any spaces.)

**Channel.** If you set the Camera to Ad-Hoc mode, select the appropriate channel from the drop-down menu. All devices in your wireless ad-hoc network must use the same channel in order to function correctly.

Then click the **Next** button.

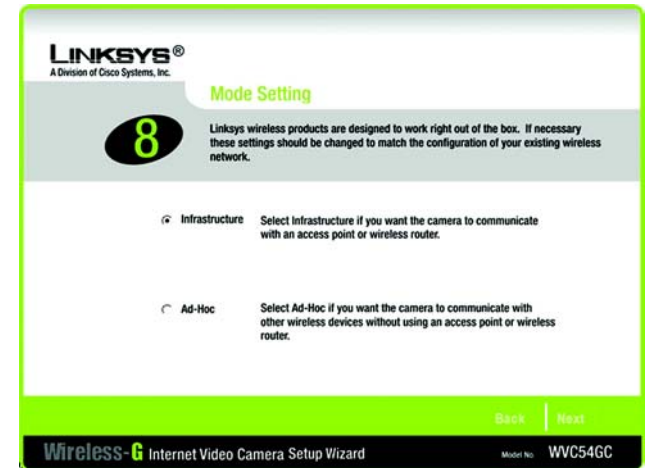

Figure 5-12: Mode Settings Screen

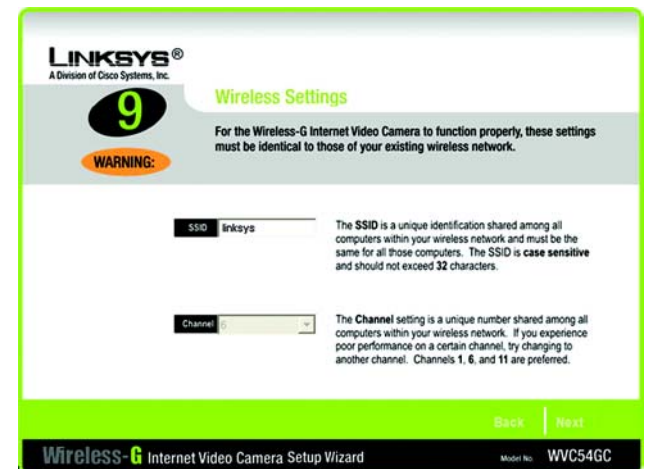

Figure 5-13: Wireless Settings Screen



15. Configure the wireless security settings. Select the method your network is using, WPA-Personal, WEP (128-Bit), or WEP (64-Bit). Then proceed to the appropriate instructions. If you are not using wireless security, select **Disabled**, and proceed to step 10.

### WPA-Personal

WPA-Personal automatically uses TKIP with dynamic encryption keys. Enter a passphrase on this screen.

**Encryption** - TKIP is automatically selected as the encryption method.

**Passphrase** - Enter a Passphrase, also called a pre-shared key, of 8-63 characters in the *Passphrase* field. The longer and more complex your Passphrase is, the more secure your network will be.

Click **Next** to proceed, or click **Back** to return to the previous screen.

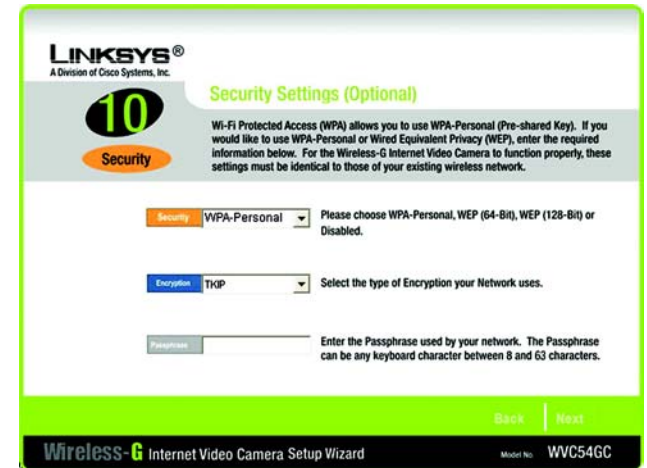

Figure 5-14: Security Settings - WPA-Personal Screen

### WEP (128-Bit) or WEP (64-Bit)

Enter a passphrase in the *Passphrase* field and click **Next**. If you want to manually enter a WEP key, leave the *Passphrase* field blank, and enter the WEP key in the *Key 1* field. Then click **Next**.

**Passphrase** - Enter a passphrase in the *Passphrase* field, so a WEP key is automatically generated. The passphrase is case-sensitive and should not be longer than 16 alphanumeric characters. It must match the passphrase of your other wireless network devices and is compatible with Linksys wireless products only. (If you have any non-Linksys wireless products, enter the WEP key manually on those products.)

**Key 1** - The WEP key you enter must match the WEP key of your wireless network. For 64-bit WEP encryption, enter exactly 10 hexadecimal characters. For 128-bit WEP encryption, enter exactly 26 hexadecimal characters. Valid hexadecimal characters are "0" to "9" and "A" to "F".

Click **Next** to proceed, or click **Back** to return to the previous screen.

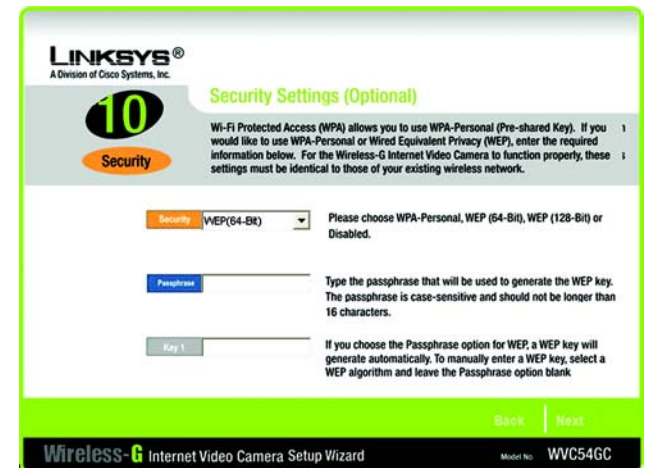

Figure 5-15: Security Settings - WEP (64-Bit) Screen



16. Review your settings before you save your new settings. Click the **Next** button to continue.



Figure 5-16: Review New Settings Screen

17. Click **OK** to confirm that you want to save the new settings. If you want to cancel your changes, click **Cancel**.

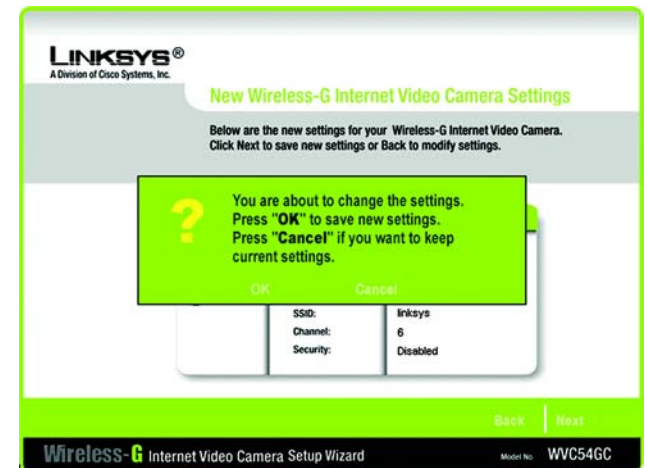

Figure 5-17: Confirm New Settings Screen

18. After the files have been successfully copied, the *Congratulations* screen will appear.

**Install Viewer & Recorder Utility.** Click this button to install the Camera's Utility on your PC.

**Setup SoloLink DDNS Service.** Click the **Setup SoloLink DDNS Service** button to set up and configure the Linksys Dynamic Domain Name System (DDNS) service.

**User Guide.** Click this button to open the PDF file of this User Guide.

**Exit.** Click the **Exit** button if you want to install the Camera's Utility later.

Go to the "Placement Options" section.



Figure 5-18: Congratulations Screen

## Placement Options

The Camera can stand on a surface or be mounted on a wall. Depending on the positioning you want, you can attach the Camera head to its stand at two different points.

### Stand Option

1. Insert the screw end of the stand into the hole on the bottom panel.
2. Tighten the screw end and then the gray thumbscrew.
3. Place the Camera, and adjust the tilt of its head accordingly.



Figure 5-19: Stand Option



Figure 5-20: Camera in Standing Position

## Wall Mount Option

You will use the Camera's stand to mount the Camera on a wall. Its stand has two wall-mount slots that are spaced 58 mm (2.28 inches) apart.

1. Insert the screw end of the stand into the hole on the back panel.
2. Tighten the screw end and then the gray thumbscrew.
3. Determine where you want to mount the Camera. Attach two screws to the wall, so that the Camera's wall-mount slots line up with the two screws.
4. Maneuver the Camera so the screws are inserted into the two slots.
5. Adjust the tilt of its head accordingly.

**The installation of the Compact Wireless-G Internet Video Camera is complete. Go to "Chapter 6: Installing the Compact Wireless-G Internet Video Camera Multi-Camera Viewer & Recorder Utility."**

**If advanced users wish to access the Camera through its Web-based Utility, then proceed to "Chapter 8: Using the Compact Wireless-G Internet Video Camera Web-based Utility."**



Figure 5-21: Wall Mount Option



Figure 5-22: Camera in Wall-Mounting Position

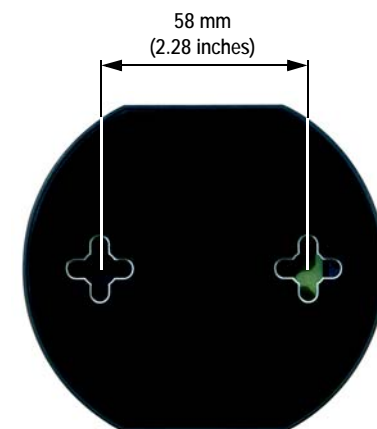

Figure 5-23: Wall-Mount Slots

# Chapter 6: Installing and Using the Compact Wireless-G Internet Video Camera Multi-Camera Viewer & Recorder Utility

## Overview

This chapter will instruct you on how to install and use the Compact Wireless-G Internet Video Camera Multi-Camera Viewer & Recorder Utility on your PC. The Utility allows you to easily view and record the Camera's video.

If the Wireless-B or G Internet Video Camera Viewer & Recorder Utility has already been installed on your PC, Linksys recommends that you uninstall it before you install the Compact Wireless-G Internet Video Camera Multi-Camera Viewer & Recorder Utility (this Utility will also work with Wireless-B or G Internet Video Cameras).



**NOTE:** To view video using a web browser, you must use Internet Explorer version 5.5 or higher. The View Video feature will not work with Netscape. Netscape users should use the Multi-Camera Viewer & Recorder Utility instead.

## Installing the Multi-Camera Viewer & Recorder Utility

1. On the *Welcome* or *Congratulations* screen of the Setup Wizard, click the **Install Viewer & Recorder Utility** button.
2. The *Welcome* screen will appear. Click the **Next** button to proceed.



Figure 6-1: Install Viewer & Recorder Utility Screen



Figure 6-2: Install Viewer & Recorder Utility - Welcome Screen

## Compact Wireless-G Internet Video Camera

- The *Choose Destination Location* screen will appear. To install the Multi-Camera Viewer & Recorder Utility files in the default folder, click the **Next** button. To select a different folder, click the **Change** button and follow the on-screen directions.

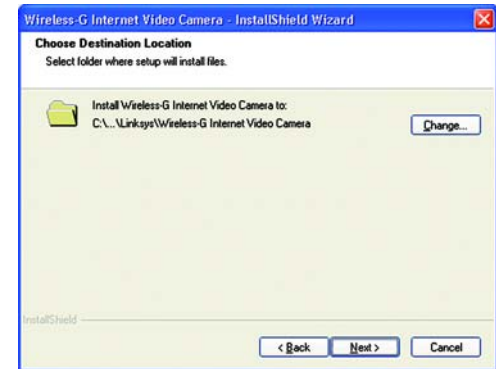

Figure 6-3: Choose Destination Location Screen

- The *Ready to Install the Program* screen will appear. Click the **Install** button to begin the installation.

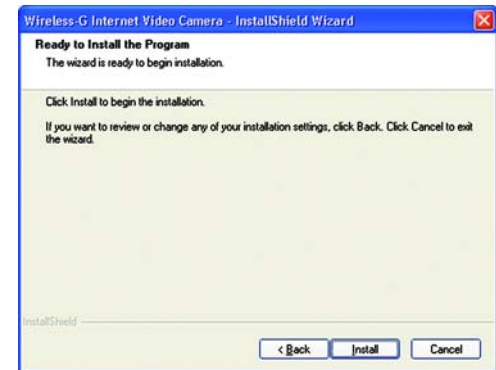

Figure 6-4: Ready to Install the Program Screen

- When the setup is complete, click the **Finish** button.

To learn how to use the Multi-Camera Viewer & Recorder Utility, proceed to the next section, “Using the Multi-Camera Viewer & Recorder Utility.”

To set up the Linksys SoloLink Service, go to “Chapter 7: Setting up the Linksys SoloLink DDNS Service.”

Advanced users: If you want to use the Camera’s Web-based Utility, go to “Chapter 8: Using the Compact Wireless-G Internet Video Camera Web-based Utility.”



Figure 6-5: InstallShield Wizard Complete Screen

## Using the Multi-Camera Viewer & Recorder Utility

After the Multi-Camera Viewer & Recorder Utility has been installed, the Multi-Camera Viewer & Recorder Utility icon will be displayed in two locations, one on your desktop and one in the system tray of your desktop's taskbar.



**NOTE:** This Multi-Camera Viewer & Recorder Utility is backward-compatible with the Wireless-B Internet Video Camera, so you can use this Utility to control Wireless-G and Wireless-B Internet Video Cameras on your network.

There are two ways to open the Multi-Camera Viewer & Recorder Utility:

- Double-click the icon on your desktop (the icon acts as a shortcut)
- Right-click the icon in the system tray, and then click **Main Program**.

You will see the Utility's main screen.

It is divided into three sections, *Camera Status*, Camera functions, and viewing windows for Channels 1-8 of the Utility. (To view different windows, use the scroll bar on the right.)

Camera functions include finding or deleting Cameras, changing Camera settings, scheduling recordings, accessing saved files, and configuring the motion detection settings.

To configure the Utility settings, click the **Utility Settings** button. To get help information, click the ? button in the upper right-hand corner. To minimize the Utility, click the – button in the upper right-hand corner. To exit the Utility, click the X button in the upper right-hand corner.

### Camera Status

This section lists all of the Cameras the Utility has detected. To view the video of a specific Camera, select a Camera. Drag and drop the Camera to a viewing window.

**CH.** Displayed here is the Channel setting used by the Camera within the Utility. (The Utility offers up to eight channels.)

**Camera Name.** This is the name you gave to the Camera.

**AUDIO ON/OFF.** The Compact Wireless-G Internet Video Camera does not feature audio; however, other Cameras do. This displays the status of their audio transmissions.

**VIDEO ON/OFF.** This indicates the status of the Camera's video transmissions.



Figure 6-6: Multi-Camera Viewer & Recorder Utility Icon



Figure 6-7: Main Screen

## Add Camera

To add a Camera on your local network or the Internet, click **Add Camera**.

The *Add Camera* screen will appear. There will be two tabs available, LAN and Internet.

### LAN

The *LAN* screen shows the Cameras found on your local area network, along with the status information for each Camera.

#### Cameras on LAN

The Utility will search for Cameras on the local area network and display a list in the *Cameras on LAN* box. To run a new search, click the **Search** button.

For the Camera whose name is currently selected in the *Cameras on LAN* box, the following information will be displayed:

#### Camera Data

**Camera Name.** This is the name you gave to the Camera.

**MAC Name.** Displayed here is the MAC address of the Camera.

**Description.** This is the information about the Camera that you entered.

**Address.** Shown here is the Camera's IP address.

**Port Number.** This is the port number the Camera uses for communication.

**Login.** If you set up the Camera with a name and password, then you will need to enter them here in order to access the Camera.

**Name.** Enter the login Name.

**Password.** Enter the login Password.

To add a Camera to the Utility's list, select the Camera you wish to add by clicking its name in the *Cameras on LAN* box. Then click the **Add** button. You will be notified when the Camera has been added. Click the **OK** button.

To close this screen, click the **X** button in the upper right-hand corner.



Figure 6-8: Add Camera - LAN Screen



## Internet

The *Internet* screen shows the Camera found on the Internet, along with the status information for it.

## Test Results

First, go to the *Camera Data* section. Enter the Camera's IP Address, Port Number, and login information (if required). Then click the **Connect** button to find the Camera. The following information will be displayed:

## Camera Data

**Camera Name.** This is the name you gave to the Camera.

**MAC Name.** Displayed here is the MAC address of the Camera.

**Description.** This is the information about the Camera that you entered.

**Address.** Shown here is the Camera's IP address or SoloLink DDNS address.

**Port Number.** This is the port number the Camera uses for communication.

**Login.** If you set up the Camera with a name and password, then you will need to enter them here in order to access the Camera.

**Name.** Enter the login Name.

**Password.** Enter the login Password.

To add the Camera to the Utility's list, click the **Add** button. If you wish to clear a Camera, click the **Clear** button.

To close this screen, click the **X** button in the upper right-hand corner.

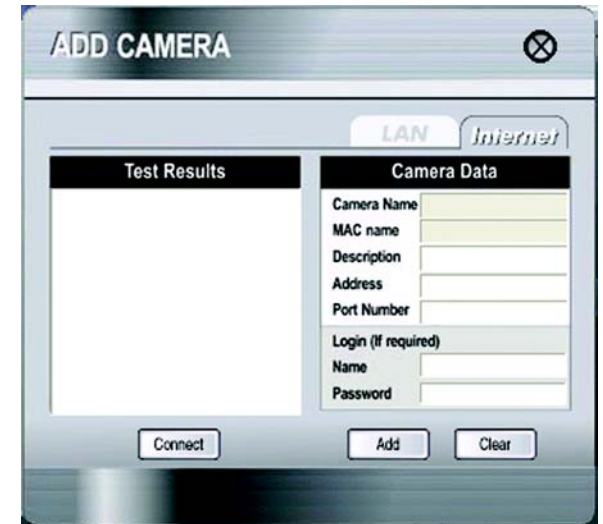

Figure 6-9: Add Camera - Internet Screen

## View Video

The Camera Status section lists all of the Cameras the Utility has detected. To view the video of a specific Camera, select a Camera. Drag and drop the Camera to a Channel (viewing) window.

Double-click the viewing window if you want to make the viewing window larger, record, play, stop, take pictures, or zoom. (For Cameras with audio, you can also raise or lower the volume.) To close this viewing window, click the X button in the upper right-hand corner.









Icon	Function
	If you want to record the current video, click this icon.
	If you want to play the current video, click this icon.
	If you want to freeze the current frame of video or stop recording, click this icon.
	To take a snapshot of the current frame of video, click this icon.
	A digital zoom feature is available. To zoom in on a section of the window, click this icon. Then use your mouse to select the section you want to magnify. Click the icon again to disable the zoom feature.
	For Cameras that feature audio, click this icon to turn audio on or off. (The Compact Wireless-G Internet Video Camera does not feature audio.)
	For Cameras that feature audio, click this bar and move its endpoint to raise or lower the volume.
	This indicates the Channel setting used by the Camera within the Utility. (You cannot use this icon to change the Camera's Channel setting; instead, you must return to the main menu. Drag and drop the Camera to a different viewing window with the Channel setting you want.)
	If you want to make the viewing window twice as large, click this icon.



Figure 6-10: View Video Screen

## Delete Camera

To delete a Camera, select its name in the *Camera Status* section, and click **Delete Camera**. When you are asked to confirm the deletion, click the **OK** button.

## Camera Settings

To modify a Camera's settings, select its name in the *Camera List* box, and click **Change Settings**.

## Test Results

Click the **Test** button to check the connection. The results will be displayed. If you need to change the Camera's network settings or login information, you can do so on this screen.

## Camera Data

**Camera Name.** This is the name you gave to the Camera.

**MAC Name.** Displayed here is the MAC address of the Camera.

**Description.** This is the information about the Camera that you entered.

**Address.** Enter the Camera's new IP address or SoloLink DDNS address.

**Port Number.** Enter the new port number that the Camera uses for communication.

**Login.** If you set up the Camera with a name and password, then you can change them here.

**Name.** Enter the new login Name.

**Password.** Enter the new login Password.

Click the **Save** button to save the new settings.

To close this screen, click the **X** button in the upper right-hand corner.



Figure 6-11: Delete Camera Screen



Figure 6-12: Change Settings Screen

## Scheduled Recordings

To schedule recordings for a Camera, select its name in the *Camera List* box, and click **Scheduled Recording**.

A list of scheduled recordings will appear.

**Frequency.** Decide which days you want the Camera to record. Select the appropriate Frequency from the drop-down menu.

**Start Time.** Select the time you want the recording to begin.

**Duration.** Select how long you want the recording to be.

After you have made your selections, click the **Add** button to save the new scheduled recording.

To delete a scheduled recording, select the recording from the list, and click the **Delete** button.

To close this screen, click the **X** button in the upper right-hand corner.

You may find it helpful to know how much memory is required to hold a video recording. The following table lists estimated bit rates and file sizes for a typical video recording at each available resolution and video.

### Estimated Hard-Drive Memory Space Required for Video Recording per Hour

Resolution	Quality Level	Bit Rate	File Size
320 x 240	Very High	900kbps	430MB
320 x 240	High	500kbps	330MB
320 x 240	Normal	300kbps	240MB
320 x 240	Low	120kbps	230MB
320 x 240	Very Low	40kbps	225MB
160 x 120	Very High	800kbps	380MB
160 x 120	High	400kbps	270MB
160 x 120	Normal	200kbps	230MB
160 x 120	Low	100kbps	220MB
160 x 120	Very Low	40kbps	210MB



Figure 6-13: Scheduled Recordings Screen



**NOTE:** In order for the scheduled recordings to occur, the Multi-Camera Viewer & Recorder Utility must be running on a networked PC.



**NOTE:** The maximum length of a recording file is one hour. If a recording is more than one hour long, then multiple files will be saved.

## Saved Files

To access the saved files of a Camera, select its name in the *Camera List* box, and click **Saved Files**. You have three types of files available: Recorded Videos, Motion Detection Videos, and Snapshot Pictures.

To close this screen, click the **X** button in the upper right-hand corner.

### Recorded Files

Click the **Recorded Videos** button, and the *Recorded Files* screen will appear and display a list of files, organized by Camera Name, File Name, and Start Time.

**Camera Name.** This is the name of the Camera that was used.

**File Name.** Displayed here is the name of the file. If it was an instant recording, the filename format is "LAN\_R\_(date)\_(end time)". If it was a scheduled recording, the filename format is "LAN\_(date)\_(end time)".

**Start Time.** This is the time the recording began.

To play a recording, select the appropriate file and click the **Play** button. To delete a recording, select the appropriate file and click the **Delete** button. If the recorded file you want is not listed, click the **Explore** button to find it. To rename a recorded file, click the **Explore** button. After you have found the file, you can rename it.

To close this screen, click the **X** button in the upper right-hand corner.

### Motion Detection Files

Click the **Motion Detection Videos** button, and the *Motion Detection Files* screen will appear and display a list of files, organized by Camera Name, File Name, and Start Time. (Click **Motion Detection** on the main menu to access the *Motion Detection Settings* screen).

**Camera Name.** This is the name of the Camera that was used.

**File Name.** Displayed here is the name of the file.

**Start Time.** This is the time the recording began.

To play a video, select the appropriate file and click the **Play** button. To delete a file, select the appropriate file and click the **Delete** button. If the file you want is not listed, click the **Explore** button to find it. To rename a file, click the **Explore** button. After you have found the file, you can rename it.

To close this screen, click the **X** button in the upper right-hand corner.



Figure 6-14: Files Screen



Figure 6-15: Recorded Files Screen



**NOTE:** Use Windows Media Player 7 or higher to view your recordings.

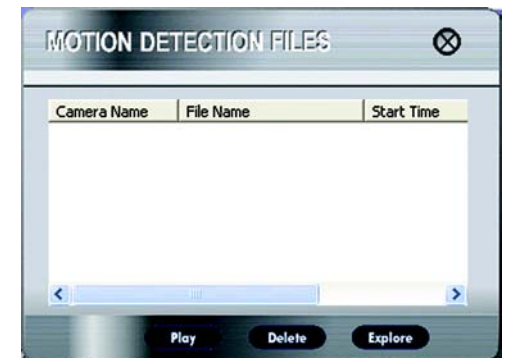

Figure 6-16: Motion Detection Files Screen

## Snapshots

Click the **Snapshot Pictures** button, and a Windows Explorer window will appear and display the available SnapShot folders. The name of each folder is the MAC address of the Camera that took that folder's snapshots. Double-click a folder to see a list of its images.

## Motion Detection

You can have video recorded when the Utility detects motion in a Camera's field of view. To configure these settings, select its name in the *Camera List* box, and click **Motion Detection**.

A list of scheduled motion detection recordings will appear.

**Frequency.** Decide which days you want the Camera to monitor its field of view for motion. Select the appropriate Frequency from the drop-down menu.

**Start Time.** Decide what time you want the Camera to begin monitoring for motion. Select the time you want the video recording to begin.

**Duration.** Select how long you want the Camera to monitor for motion.

**Sensitivity Level.** You have a choice of motion sensitivity levels for the Camera. Select the appropriate level from the drop-down menu.

**3 x 3 (default).** By default, the Camera's field of view is split into nine sections (see the on-screen image). If you want it split into 16 sections, select **4 x 4**. If you want it split into 25 sections, select **5 x 5**.

On the on-screen image depicting the Camera's field of view, click the sections you want monitored. The selected sections will be marked by a crisscross pattern. If you want to select all sections, click the **Select All** button. If you want to de-select all sections, click the **Clear All** button. To refresh the current image, click the **Refresh Image** button.

After you have made your selections, click the **Add** button to save the new scheduled motion detection video.

To delete a scheduled motion detection video, select the video from the list, and click the **Delete** button.

To close this screen, click the **X** button in the upper right-hand corner.



**NOTE:** In order for the motion detection feature and its recordings to occur, the Multi-Camera Viewer & Recorder Utility must be running on a networked PC.

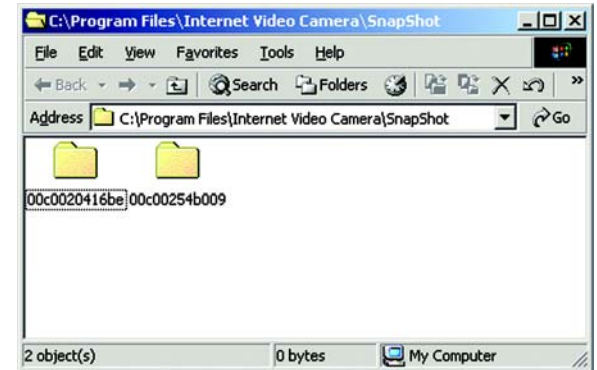

Figure 6-17: Window Showing SnapShot Folders

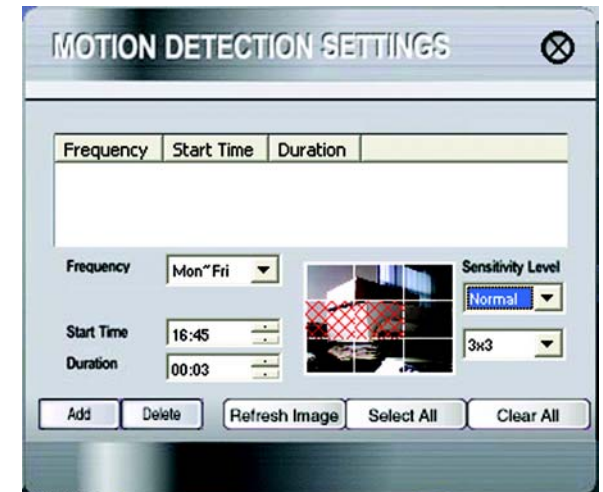

Figure 6-18: Motion Detection Settings Screen



**NOTE:** To specify the maximum length for a single motion detection video recording, click the **Utility Settings** button on the main menu.



## Utility Settings

To configure the settings of the Multi-Camera Viewer & Recorder Utility, click the **Utility Settings** button.

The *Utility Settings* screen will appear. You can change the Directory, Recording Time Frame, Disk Allocation for Recording, and Start Info. settings on this screen.

### Directory

You can specify the directories where the recordings, motion detection videos, and snapshots will be saved.

**Recording Directory.** Instant and scheduled recordings will be saved in this directory. The default is **C:\Program Files\Linksys\Wireless-G Internet Video Camera\Record**. Click the ... button to designate a different directory.

**Motion Detection Directory.** Motion detection video recordings will be saved in this directory. The default is **C:\Program Files\Linksys\Wireless-G Internet Video Camera\Motion**. Click the ... button to designate a different directory.

**Snapshot Directory.** Snapshots will be saved in this directory. The default is **C:\Program Files\Linksys\Wireless-G Internet Video Camera\Snapshot**. Click the ... button to designate a different directory.

### Recording Time Frame

You can specify the maximum length of motion detection and instant recordings.

**Maximum time frame for Motion Detection Recording.** This is the maximum length of time the Utility will record when motion is detected. (To configure the Motion Detection settings, click **Motion Detection** on the main menu.) The default is **1 min**. To change the default, select the maximum length of time you want from the drop-down menu.

**Maximum time frame for Instant Recording.** This is the maximum length of time the Utility will record when you click the Instant Recording icon on the viewing window of a Camera. The default is **10 min**. To change the default, select the maximum length of time you want from the drop-down menu.

### Disk Allocation for Recording

You can designate how much hard disk space you want to use for recording.

**Total Space.** This is the total amount of space available on the hard drive of the PC running this Utility.

**Total Space and Available Space.** This is the amount of space available for recording.

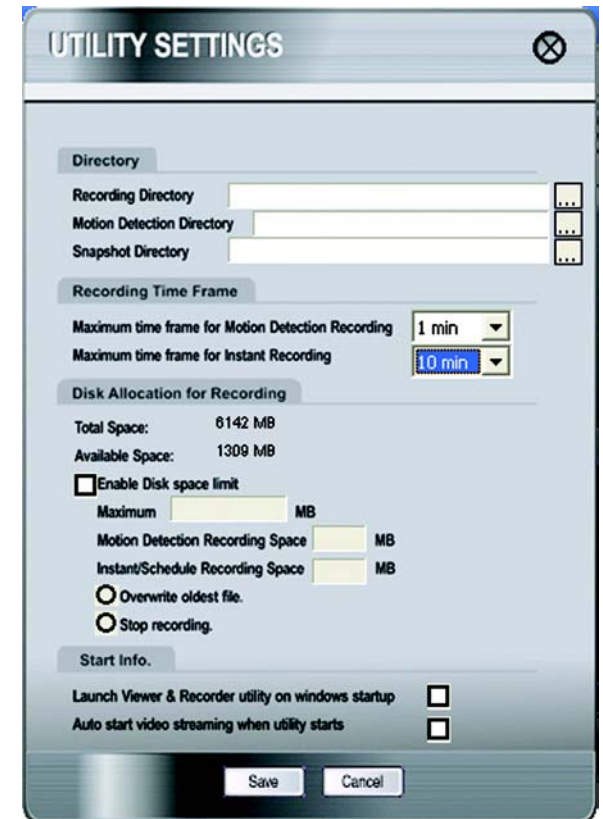

Figure 6-19: Utility Settings Screen

**Enable Disk space limit.** If you want to limit the amount of disk space available for recording, click the checkbox. Enter the maximum number of megabytes in the *Maximum* field.

Of the total amount of disk space available for recording, you can designate the amount of space available for motion detection recordings. Enter the maximum number of megabytes in the *Motion Detection Recording Space* field.

Of the total amount of disk space available for recording, you can designate the amount of space available for instant and scheduled recordings, enter the maximum number of megabytes in the *Instant/Scheduled Recording Space* field.

If the hard drive runs out of space, the Utility has two options. It can overwrite the oldest files or stop recording. Select the option you want, **Overwrite oldest file** or **Stop recording**.

Start Info.

You can designate when and how you want the Utility to launch.

**Launch Viewer & Recorder utility on Windows startup.** If you want the Utility to launch when Windows starts up, click the checkbox.

**Auto start video streaming when utility starts.** If you want video to automatically begin streaming when the Utility launches, click the checkbox.

After you have made your changes, click the **Save** button to save the new settings.

To cancel your changes, click the **Cancel** button.

To close this screen, click the **X** button in the upper right-hand corner.

**To set up the Linksys SoloLink Service, go to “Chapter 7: Setting up the Linksys SoloLink DDNS Service.”**

**If you want to use the Camera’s Web-based Utility, go to “Chapter 8: Using the Compact Wireless-G Internet Video Camera Web-based Utility.”**



# Chapter 7: Setting up the Linksys SoloLink™ DDNS Service

## Overview

This chapter will briefly discuss the Linksys SoloLink DDNS Service, explain how to set up your SoloLink account, and describe how to register additional Cameras on your SoloLink account. You need only one SoloLink account. Once you have set up your account, you can register additional Cameras, one at a time, through each Camera's Web-based Utility. This way each Camera can take advantage of the SoloLink DDNS Service.

## Introduction

The SoloLink DDNS (Dynamic Domain Name System) Service lets you assign a fixed host and domain name to a dynamic Internet IP address. The instructions in this chapter will guide you through the setup needed for use of the SoloLink DDNS Service. For the most current information about the SoloLink DDNS Service, visit [www.linksys.com/sololink](http://www.linksys.com/sololink). For a free, 90-day trial period of your SoloLink account, use the Access ID Card included with the Camera.

You may want to use the Linksys SoloLink DDNS Service if one of the following applies to you:

**Dynamic IP Address** - Your Internet service assigns you a dynamic IP address. Many Internet service providers (ISPs) assign a new IP address to your connection from time to time (for security purposes), or whenever you disconnect and reconnect. The SoloLink service keeps track of your network's address, even when it changes, so you can "find" the Camera.

**Convenience** - There are a couple of ways the SoloLink service can be convenient. If you have a static IP address, you can use the SoloLink service to enter a "name" and port number for remote access of the Camera via the Internet. There's no need to type an entire IP address. For example, you can give a Camera a "name" such as `cam1.myhouse.ourlinksys.com`.

Also, some DDNS services require your PC to continuously run software that lets them keep track of your IP address. If your PC isn't powered on when your IP address changes, you won't be able to find the Camera on the Internet. The SoloLink service keeps track of where the Camera is.

## Setup Wizard for the SoloLink DDNS Service

1. On the *Welcome* or *Congratulations* screen of the Setup Wizard, click the **Setup SoloLink DDNS Service** button.



Easily access your video camera remotely over the Internet with  
**SoloLink** DDNS Service  
To activate your SoloLink account, click on the SoloLink tab on the Setup Wizard or on the Web-based Utility. Use the Access ID Card included with your product to get your SoloLink account **FREE for 90 days**

Figure 7-1: SoloLink Service



Figure 7-2: SoloLink Welcome Screen

2. This screen explains why you would want to use the SoloLink DDNS Service if your network is using a dynamic IP address. Click the **Next** button.

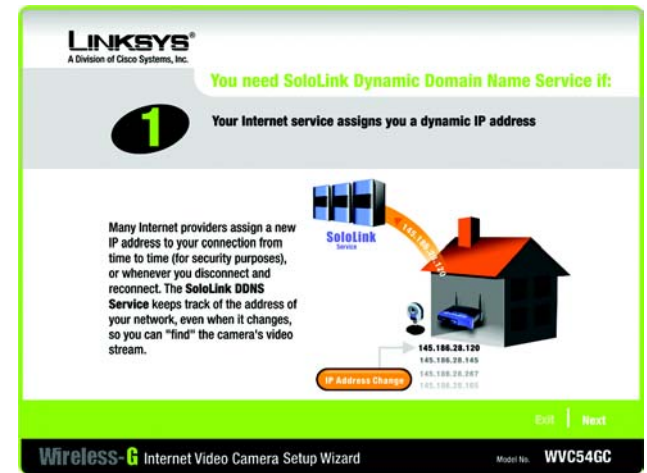

Figure 7-3: SoloLink for Dynamic IP Address Screen

3. This screen explains why you would find the SoloLink DDNS Service convenient if you would prefer to access the Camera using a name rather than a series of numbers (its IP address). Click the **Next** button.

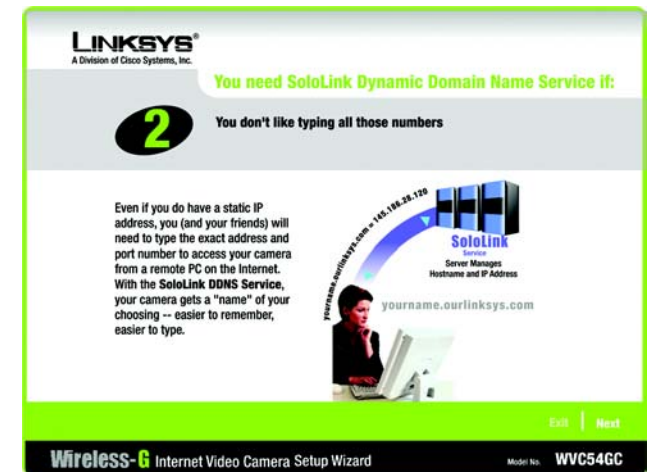

Figure 7-4: SoloLink for Convenience Screen

## Compact Wireless-G Internet Video Camera

4. Make sure your network has an active Internet connection. Verify that your PC and Camera are connected to the network and the Camera is configured properly. Click **Next**.

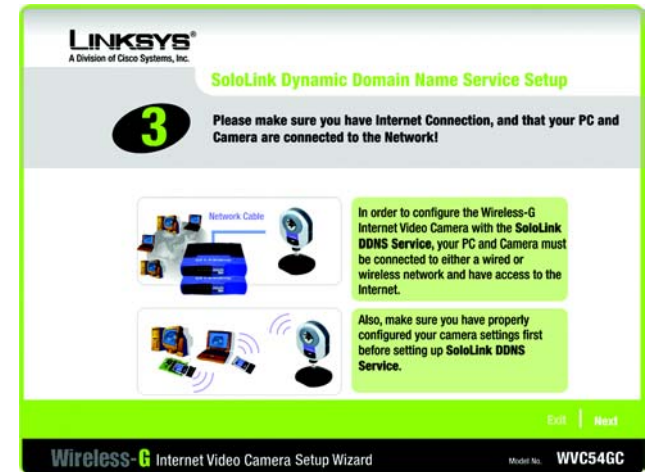

Figure 7-5: Check Connections Screen

5. This screen displays a list of Compact Wireless-G Internet Video Cameras on your network and their status information. In the *Selection* box, click the name of the Camera you are currently setting up. Click **Next**.



Figure 7-6: Cameras Found Screen

## Compact Wireless-G Internet Video Camera

- To ensure security, you will be asked to enter a user name and password before you can access the Camera. If you have not changed the Camera's user name and password, then enter **admin** in the *User name* and *Password* fields (**admin** is the default). Then click **OK**.



Figure 7-7: Login Screen

- Your web browser will automatically start up, and the *SoloLink DDNS* screen of the Camera's Web-based Utility will appear. Click **New User ? - Click here to Register**.



Figure 7-8: SoloLink DDNS Screen

8. Make sure your network has an active Internet connection. Click **Continue**.



Figure 7-9: Confirm Active Internet Connection Screen

9. On the *Welcome to the SoloLink DDNS Service* screen, click **Set up a NEW Account**.



Figure 7-10: Welcome to the SoloLink DDNS Service Screen

## Compact Wireless-G Internet Video Camera

10. On the *Sign Up* screen, enter the Access ID for your free trial offer. It is provided on the Promotion Card included with the Camera. (If you don't have an Access ID, then leave the *Access ID* field blank.)

Then enter your account and user information. Enter a Username and Password for your account. Enter the Password again in the *Confirm Password* field.

Complete the following required fields: *First Name*, *Last Name*, *Phone*, and *Email*. You can also enter your postal address and choose to receive updates by e-mail. Then click **Continue**.

**FREE** for 90 days

### Sign Up

Sign up for the Linksys SoloLink DDNS Service in order to get your easy-to-remember name (you may purchase a new one) to access your Linksys Internet Video Camera no matter how many times your broadband provider changes your IP address.

The FREE trial offer will give you an opportunity to try out this amazing service for 90 days. To activate your FREE trial offer please use the Access ID you received on the Promotion Card here.

Access ID

There are special rates available if you want to sign up **NOW** for one or two years:

**\$19.99** for 1-year (and get 30 days free => 15 months for \$19.99)  
**\$34.99** for 2-year (and get 30 days free => 27 months for \$34.99)

If you sign up after you register for the 90-day trial offer you will pay \$24.99 for one year or \$39.99 for 2 years.

#### Account Information

Username

This is the user name for your SoloLink account, not your camera's name.

Password

Confirm Password

#### User Information

Fields marked with an \* are required.

First Name

Last Name

Address 1

Address 2

City

State

Zip

Country

Phone

Email

Receive Updates by Email  Yes  No

**Continue >>**

Figure 7-11: Sign Up Screen

11. Review your information on the *Confirmation* screen. If the new settings are correct, click **Continue**.

The Confirmation screen is divided into two main sections: Account Information and User Information. The Account Information section includes fields for Username (jdoe), Password (xxxxx), and Confirm Password (xxxxx). The User Information section includes fields for First Name (John), Last Name (Doe), Address 1 (1234 Street Address), Address 2, City (My City), State (My State), Zip (My Zip Code), Country (USA), Phone (My Phone), and Email (jdoe@email.com). There is also a checkbox for 'Receive Updates by Email' which is checked (Yes). At the bottom, there are '<< Back' and 'Continue >>' buttons. A warning message at the bottom states: 'If any of the information above is incorrect click the BACK button.'

Figure 7-12: Confirmation of New Settings Screen

12. On the *Select a Location ID* screen, enter a Location ID, which can be a name describing your network's location. It will be combined with the Camera's Device Name and *ourlinksys.com* to create a convenient URL you can use to access the Camera. Click **Continue**.

The Setup 1 - Select a Location ID screen provides instructions on how to choose a Location ID. It explains that the Location ID must consist of letters, numbers, and hyphens (no spaces). It also shows an example: 'cam1 myhouse ourlinksys.com', where 'myhouse' is the Location ID. Below the instructions is a text input field labeled 'Enter Location ID here.' with a placeholder '[Device Name] jdoehouse ourlinksys.com'. A 'Continue >>' button is located at the bottom right.

Figure 7-13: Select a Location ID Screen



13. On the *Confirm your Location ID* screen, verify that the Location ID is correct. Then click **Continue**.



Figure 7-14: Confirm Your Location ID Screen

14. On the *Payment* screen, choose one of two payment plans, **Bill me now** or **Bill me later**. (If you did not enter an Access ID, then you have one choice, **Bill me now**.)

If you click *Bill me later*, go to step 15.

If you click *Bill me now*, you will see a screen asking for billing information. Follow the on-screen instructions and then go to step 15.



Figure 7-15: Payment Screen

15. Read the Terms of Service agreement on the *Verification* screen. Click **Create Account** to accept the terms of service.



Figure 7-16: Verification Screen



16. On the *Create Links* screen, click **Continue**. The SoloLink DDNS Service will send your account information to the Camera.



Figure 7-17: Create Links Screen

17. A pop-up screen will inform you that you have successfully registered your account. Click **OK**.

At the bottom of the *SoloLink DDNS* screen, click the **Apply** button to register the Camera with your account.



Figure 7-18: Successful Registration Screen

18. A confirmation page will display the link or address you will use to access the Camera and the port number the SoloLink DDNS Service will use to find the Camera. Click **Continue**.

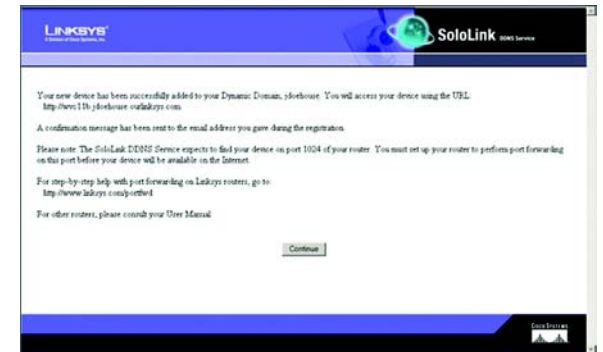

Figure 7-19: Account Confirmation of Camera Screen

19. A pop-up screen will inform you that you have successfully set up the SoloLink DDNS Service for the Camera. Click **OK**.



**NOTE:** Make sure you set up the port forwarding feature on your network router, so the SoloLink DDNS Service will be able to access the Camera.



Figure 7-20: Successful Setup Screen

20. Set up port forwarding on your network router, so the SoloLink DDNS Service will be able to track the Compact Wireless-G Internet Video Camera. Go to [www.linksys.com/portfwd](http://www.linksys.com/portfwd) for instructions on how to configure a Linksys router.

For other routers, refer to your router's documentation.

The SoloLink DDNS setup is complete. If you want to register more Cameras with your SoloLink account, proceed to the "SoloLink Registration of Additional Cameras" section.

For more information about the Camera's Web-based Utility, proceed to "Chapter 8: Using the Compact Wireless-G Internet Video Camera Web-based Utility."

## SoloLink Registration of Additional Cameras

After you have set up your SoloLink account, you can add more Cameras to your SoloLink account using each Camera's Web-based Utility. Follow these instructions for each Camera you add:

1. To access a Camera's Web-based Utility, launch **Internet Explorer**, and enter the Camera's IP address in the **Address** field. (The default IP address is **192.168.1.115**.) Then press **Enter**.
2. The *Welcome* screen will appear. Click the **Setup** tab.
3. A login screen will appear. (Windows XP users will see a similar screen.) Enter **admin** (the default user name and password) in the *User Name* and *Password* fields. Then click the **OK** button.
4. Click the **SoloLink DDNS** tab.



Figure 7-21: Port Forwarding Information



Figure 7-22: Web-based Utility Welcome



Figure 7-23: Web Utility Login Screen

5. In the *Username*, *Password*, and *Your Domain* fields, enter your SoloLink account information.
6. In the *Device Name* field, give the Camera a unique name. The DDNS service will not work if multiple Cameras have the same Device Name.
7. In the *WAN Port* field, enter a unique port number. This is the number of the port you will use to access the Camera remotely. (If you need to find an available port, click **Find Available Port** and follow the on-screen instructions). The DDNS service will not work if multiple Cameras use the same WAN port.
8. Depending on how often you want the DDNS service to update the dynamic IP address, select the appropriate time interval from the *DDNS Service Update* drop-down menu. To update the dynamic IP address immediately, click the **Update Now** button.
9. Click the **Apply** button on the *SoloLink DDNS* screen. The Camera will automatically register itself with your SoloLink account.
10. Set up port forwarding on your network router, so the SoloLink DDNS Service will be able to track the Compact Wireless-G Internet Video Camera. Go to [www.linksys.com/portfwd](http://www.linksys.com/portfwd) for instructions on how to configure a Linksys router.

For other routers, refer to your router's documentation.

**The Camera has been added to your SoloLink account.**

**For more information about the Camera's Web-based Utility, proceed to "Chapter 8: Using the Compact Wireless-G Internet Video Camera Web-based Utility."**



Figure 7-24: SoloLink DDNS Screen



Figure 7-25: Find Available Port Screen

# Chapter 8: Using the Compact Wireless-G Internet Video Camera's Web-based Utility

## Overview

Use the Camera's Web-based Utility to access and alter its settings. This chapter will describe each webpage in the Utility and its features. The Utility can be accessed via the web browser of a computer connected to the Camera.

## How to Access the Web-based Utility

To access the Utility, launch Internet Explorer, and enter the Camera's IP address in the *Address* field. (The default IP address is **192.168.1.115**.) Then press **Enter**.

The *Welcome* screen of the Web-based Utility will appear.

You have six tabs available:

- **Home.** To return to the *Welcome* screen, click the **Home** tab.
- **View Video.** To view the Camera's video, click the **View Video** tab. Go to the "View Video" section for more information.
- **Setup.** To alter the Camera's settings, click the **Setup** tab. Go to the "Setup" section for more information.
- **Linksys Web.** To go to the Linksys website, *www.linksys.com*, click the **Linksys Web** tab.
- **Help.** The *Help* screen allows you to get information about the various *Setup* screens, download the latest Viewer & Recording Utility, download this User Guide, and download Acrobat Reader. Go to the "Help" section for more information.
- **Exit.** To close the Utility, click the **Exit** tab.



Figure 8-1: Camera's Default IP Address



Figure 8-2: Web-based Utility Welcome

## View Video

Follow these instructions to view the Camera's video.







1. Click the **View Video** tab on the *Welcome* screen.
2. A *Security Warning* screen about an OCX plug-in may appear. To enable your computer to see the Camera's video, click the **Yes** button.
3. A screen will appear showing you the video from the Camera.



**NOTE:** To view video using a web browser, you must use Internet Explorer version 5.5 or higher. The View Video feature will not work with Netscape. Netscape users should use the Multi-Camera Viewer & Recorder Utility instead.

When viewing the Camera's video, you can resize the image, zoom, take and save snapshots, and view the image as a flip, mirror, or rotated image.

Size Selection. The default is **320 x 240**. You can also resize the image; select **640 x 480** (digitally resized) or **160 x 128** from the drop-down menu.

Icon	Function
	A digital zoom feature is available. To zoom in on a section of the window, click this icon. Then use your mouse to select the section you want to magnify.
	To take a snapshot of the current frame of video, click this icon. The snapshot will be automatically saved in the designated folder.
	To designate the folder where snapshots are saved, click this icon.
	To view the image as a flip image, click this icon.
	To view a mirror image (reversed left to right and vice versa), click this icon.
	To view the image as an image rotated 180°, click this icon.

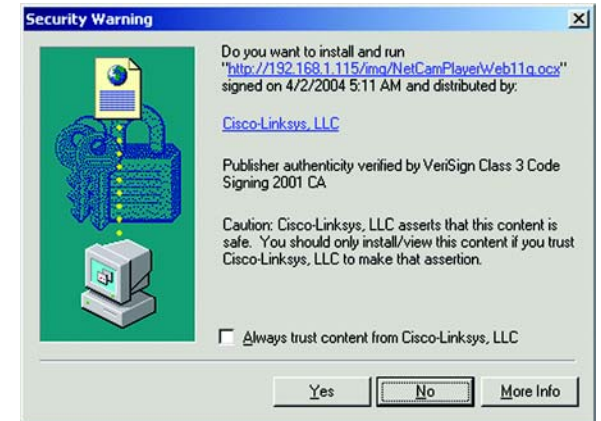

Figure 8-3: Security Warning Screen



Figure 8-4: View Video Screen

## Setup

Click the **Setup** tab on the *Welcome* screen to alter the Camera's settings. A login screen will pop up. (Windows XP users will see a similar screen.) Enter **admin** (the default user name and password) in the *User Name* and *Password* fields. Then click the **OK** button.



**NOTE:** For added security, you should always change the Login Name and Password through the *Administrator* screen of the Utility.

The *Basic* screen will appear. You have six tabs available:

- **Basic.** To configure the Camera's basic, LAN, and wireless settings, use the *Basic* screen.
- **Image.** Customize the video settings on the *Image* screen.
- **Administrator.** Alter the Administrator name and password o
- **Users.** Designate users and their level of access to the Camera on this screen.
- **SoloLink DDNS.** Set up and manage the SoloLink DDNS Service. DDNS (Dynamic Domain Name System) lets you assign a fixed host and domain name to a dynamic Internet IP address.
- **Options.** The e-mail alert options, Universal Plug and Play (UPnP) setting, and Alternate Port settings are configured on the *Options* screen.
- **Status.** Status information and a log are displayed on this screen.

To save your changes, click the **Apply** button. To cancel any unsaved changes, click the **Cancel** button. To get additional information about a screen's features, click the **Help** tab.



Figure 8-5: Web Utility Login Screen



Figure 8-6: Basic Screen



## Basic

The *Basic* screen allows you to alter the Camera's settings, including the network and wireless configuration.

### Device Settings

**Device ID.** Displayed here is the Camera's identification name, which is based on its MAC address.

**Camera Name.** You may assign any name to the Camera. Unique, memorable names are helpful, especially if you are using multiple Cameras on the same wireless network. You can enter up to 15 characters.

**Description.** Enter information about the Camera in this field. You can enter up to 32 characters.

**LED Operation.** Click the **Enable** radio button if you want the Camera's LED to light up when the Camera is working. Click the **Disable** radio button if you want the LED permanently disabled.

**Current Date/Time.** The current date and time are automatically displayed. Click the **Sync with PC** button if you want the Camera to synchronize its date and time with your PC.

**Time Zone.** Select the time zone for the Camera's location.

**Adjust for daylight savings.** To adjust the Camera's current time for daylight savings, click the checkbox.

### LAN Settings

**Configuration Type.** If the Camera will obtain an IP address automatically from a DHCP server, then select **Automatic Configuration - DHCP**. If you will assign the Camera a static IP address, then select **Fixed IP Address**, and complete the *IP Address*, *Subnet Mask*, *Gateway*, and *DNS* fields.

**IP Address, Subnet Mask, Gateway, Primary DNS, Secondary DNS.** Complete these fields if the Camera will use a static IP address. You need to enter at least one DNS address.

### Wireless Settings

**SSID.** Enter the network's SSID or network name here.

**Network Type.** Select the network's mode, **Infrastructure** or **Ad-hoc**.

**Channel No.** If the Camera is set to ad-hoc mode, select its channel setting from the drop-down menu.

**Security.** To enable wireless security, click the **Edit Security Settings** button. For more information, proceed to the "Security Settings" section.



Figure 8-7: Basic - Device Settings Screen



Figure 8-8: Basic - LAN and Wireless Settings Screen



To save your changes, click the **Apply** button. To cancel any unsaved changes, click the **Cancel** button. To get additional information about the screen's features, click the **Help** tab.

## Wireless Security

Select the security method you want to use, **WEP** or **WPA Personal** (all devices on your wireless network must use the same security settings). Then follow the appropriate instructions.

### WPA Personal

**WPA Algorithm.** TKIP is automatically selected as the encryption method.

**WPA Shared Key.** Enter the WPA Shared Key (also called Passphrase or Pre-Shared Key) used by your wireless network. It must have 8-32 characters.

To save your changes, click the **Apply** button. To cancel your changes, click the **Cancel** button.

### WEP

**TX Key.** Select which WEP key (1-4) will be used when your network's access point or wireless router sends and receives data.

**WEP Encryption.** Select the level of WEP encryption you wish to use, **64 Bit Keys (10 Hex chars)** or **128 Bit Keys (26 Hex chars)**.

**Passphrase.** Instead of manually entering WEP keys, you can use a Passphrase to generate them. It is case-sensitive and should not be longer than 16 alphanumeric characters. (This Passphrase is compatible with Linksys wireless products only. If you are also using non-Linksys wireless products, you will need to enter your WEP keys manually on those products.) After entering the Passphrase, click the **Generate** button to create WEP key(s).

**Key 1-4.** If you used a Passphrase, the WEP keys will be displayed after you have generated them. If you are not using a Passphrase, manually enter a set of values in each field. (For 128-bit WEP, only one WEP key is permitted.) If you are using 64-bit WEP encryption, then each key must consist of exactly 10 hexadecimal characters. If you are using 128-bit WEP encryption, then the key must consist of exactly 26 hexadecimal characters. Valid hexadecimal characters are "0" through "9" and "A" through "F".

**Authentication.** The default is set to **Open System**, for which the sender and the recipient do NOT use a WEP key for authentication. You can also choose **Shared Key**, when the sender and recipient use a WEP key for authentication. This setting should match the one on your network's access point or wireless router.

To save your changes, click the **Apply** button. To cancel your changes, click the **Cancel** button.



The screenshot shows the 'Wireless Security' configuration page for WPA Personal. At the top, the title 'Wireless Security' is displayed in a blue header. Below it, the 'Security Mode' is set to 'WPA Personal' in a dropdown menu. The 'WPA Algorithm' is set to 'TKIP'. The 'WPA Shared Key' field is an empty text box, with a note below it stating '(8 to 63 characters)'. At the bottom of the page, there are two buttons: 'Apply' and 'Cancel'.

Figure 8-9: Wireless Security - WPA Personal Screen



The screenshot shows the 'Wireless Security' configuration page for WEP. At the top, the title 'Wireless Security' is displayed in a blue header. Below it, the 'Security Mode' is set to 'WEP' in a dropdown menu. The 'TX Key' is set to '1' in a dropdown menu. The 'WEP Encryption' is set to '64 Bit Keys (10 Hex chars)' in a dropdown menu. The 'Passphrase' field is an empty text box, with a 'Generate' button to its right. Below the passphrase field are four 'Key' fields, each containing '0000000000'. The 'Authentication' is set to 'Open System' in a dropdown menu. At the bottom of the page, there are two buttons: 'Apply' and 'Cancel'.

Figure 8-10: Wireless Security - WEP Screen

## Image

The *Image* screen allows you to alter the Camera's video settings.

### Video Settings

**Resolution.** Select the resolution you want for viewing or recording the Camera's video. Select **320\*240** for higher resolution or **160\*120** for lower resolution.

**Image Quality.** The default is **Normal**. Select the level of quality you want for viewing or recording the Camera's video. The range varies from **Very Low** to **Very High**.

You may find it helpful to know what the bit rates are for video viewing or recording at different resolutions and image quality levels. The following table lists these estimated bit rates.

### Estimated Bit Rates for Video Viewing or Recording

Resolution	Quality Level	Bit Rate
320 x 240	Very High	900kbps
320 x 240	High	500kbps
320 x 240	Normal	300kbps
320 x 240	Low	120kbps
320 x 240	Very Low	40kbps
160 x 120	Very High	800kbps
160 x 120	High	400kbps
160 x 120	Normal	200kbps
160 x 120	Low	100kbps
160 x 120	Very Low	40kbps

**Power line frequency.** Because of how fluorescent lighting flickers, it can affect the quality of the Camera's video. Select **60 Hz** if your fluorescent lighting uses 60 Hz line voltage. Select **50 Hz** if your fluorescent lighting uses 50 Hz line voltage.

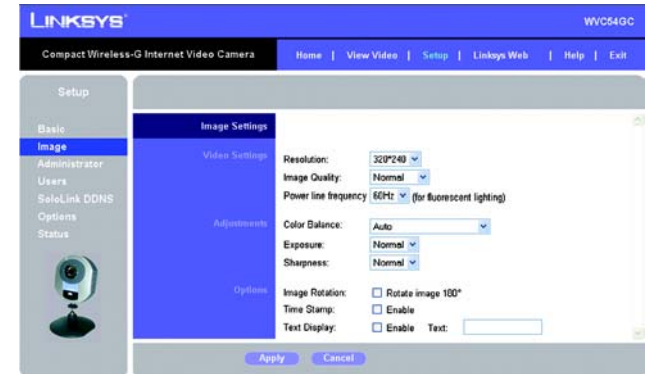

Figure 8-11: Image Screen



**NOTE:** Video quality and/or performance may be affected by the number of users connected to the Camera.

## Adjustments

**Color Balance.** Select **Auto** if you want the Camera to adjust the brightness level automatically. Select **Indoor (Incandescent)** if the Camera is in an environment using incandescent lighting, which is primarily used indoors. Select **Fluorescent (white light)** if the Camera is in an environment using fluorescent white lighting. Select **Fluorescent (yellow light)** if the Camera is in an environment using fluorescent yellow lighting. Select **Outdoor** if the Camera is used outdoors, exposed to sunlight.

**Exposure.** The default is **Normal**. Select the level of exposure you want for the Camera's video. The range varies from **-3** (underexposed) to **+3** (overexposed).

**Sharpness.** The default is **Normal**. Select the level of sharpness you want for the Camera's video. The range varies from **-3** to **+3**.

## Options

**Image Rotation.** If you want the image to be rotated 180°, click the checkbox next to *Rotate image 180°*.

**Time Stamp.** If you want a time stamp shown on the video, click the checkbox next to *Enable*.

**Text Display.** If you want text shown on the video, click the checkbox next to *Enable*. Then complete the *Text* field with up to 20 characters.

To save your changes, click the **Apply** button. To cancel any unsaved changes, click the **Cancel** button. To get additional information about the screen's features, click the **Help** tab.

## Administrator

Use this screen to change the administrator login settings, restore factory defaults, and upgrade firmware.

### Login

Changing the default name and password is recommended to secure access to the Camera's settings.

**Login Name.** Complete this field with a name of your choice.

**Password and Verify Password.** Enter your new password twice. (It should have eight or fewer characters.)

### Restore Factory Defaults

Before you restore the Camera's factory default settings, write down any custom settings you have configured. You will need to re-configure the Camera after you have restored the factory defaults.

**Restore Factory Defaults.** To restore the Camera's factory default settings, click the **Restore Defaults** button.

### Firmware Upgrade

New firmware versions are posted at [www.linksys.com](http://www.linksys.com) and can be downloaded for free. If the Camera is functioning well, there is no need to download a newer firmware version, unless that version has a new feature that you want to use. Loading new firmware onto the Camera does not always enhance its performance.

Linksys recommends that when you upgrade the Camera's firmware, use a computer within the Camera's local network. If you attempt to upgrade the Camera's firmware from a remote location—using a computer outside of the Camera's local network—the upgrade will fail.

**Upgrade Firmware.** To upgrade the firmware, follow these instructions:

1. Go to [www.linksys.com](http://www.linksys.com) and download the firmware upgrade file for the Camera. Then extract the file.
2. Click the **Upgrade Firmware** button.
3. On the *Upgrade Firmware* screen, click the **Browse** button to find the extracted file, and then double-click it.
4. Click the **Start Upgrade** button, and follow the on-screen instructions. To cancel the upgrade, click the **Cancel** button. For further help, click the **Help** tab.

To save your changes, click the **Apply** button. To cancel any unsaved changes, click the **Cancel** button. To get additional information about the screen's features, click the **Help** tab.



Figure 8-12: Administrator Screen



**NOTE:** When you restore the Camera's factory defaults, you will lose the settings you have saved previously.



**NOTE:** When you upgrade the Camera's firmware, you may lose the settings you have saved previously.



Figure 8-13: Upgrade Firmware Screen

## Users

The *Users* screen allows you to designate access rights for Camera users.

### User Access

**Allow access by.** The default is **All users**. If you keep the default setting, then all users will be allowed to view the Camera's video. If you select **Only users in database**, then only the users you enter in the database will be allowed to view the Camera's video. They will be asked to log in using their user name and password whenever they request access to the Camera's video.

### Users

You can enter up to eight users into the database. These users are then listed in the *Users* box.

**Edit.** To modify a user's settings, select the user in the *Users* box and click the **Edit** button. Make changes using the *User Name*, *User Password*, and *Confirm Password* fields. Then click the **Apply** button.

**Delete.** To remove a user from the database, select the user in the *Users* box and click the **Delete** button. Then click the **Apply** button.

**Delete All.** To remove all users from the database, click the **Delete All** button. Then click the **Apply** button.

**Add User.** To add a new user, Complete the *User Name*, *User Password*, and *Confirm Password* fields. Click the **Add User** button. Then click the **Apply** button.

**Clear/Cancel.** To clear the changes you have made in the *User Name*, *User Password*, and *Confirm Password* fields, click the **Clear/Cancel** button.

To save your changes, click the **Apply** button. To cancel any unsaved changes, click the **Cancel** button. To get additional information about the screen's features, click the **Help** tab.



Figure 8-14: Users Screen

## SoloLink DDNS

The *SoloLink DDNS* screen allows you to set up and configure your SoloLink DDNS Service. DDNS (Dynamic Domain Name System) lets you assign a fixed host and domain name to a dynamic Internet IP address. If you have already set up your SoloLink account, then you can use this screen to register additional Cameras. For instructions, go to the “SoloLink Registration of Additional Cameras” section on the following page.



**NOTE:** If you use the Camera's DDNS feature, then you must also configure the port forwarding feature on your network router. Go to [www.linksys.com/portfwd](http://www.linksys.com/portfwd) for instructions on how to configure a Linksys router. For other routers, refer to your router's documentation.

### SoloLink DDNS

**Username.** Enter the username you have set up on your SoloLink account. If you are a new user, click **New User?** - **Click here to Register**. The *New User Registration* screen will appear. Click the **Continue** button, or click the **Back** screen to return to the previous screen. Your web browser will automatically start up, and you will visit a website to set up your SoloLink account. Follow the on-screen instructions. For more information, refer to “Chapter 7: Setting up the Linksys SoloLink DDNS Service,” which will guide you through setup of your SoloLink account.

**Password.** Enter the password you have set up on your SoloLink account. If you have forgotten your password, click **Forgot your Password?**

The *Password Request* screen will appear. Complete the *Domain name* field. Click the **Continue** button to request your username and password, which will be e-mailed to the e-mail address registered with your SoloLink DDNS account. Click the **Cancel** button to cancel your change. Click the **Back** button to return to the previous screen.

**Your Domain.** Enter the host and domain name you have set up on your SoloLink account. It should be in this format: <Location ID>.ourlinksys.com. For example, if *myhouse* is the Location ID, then the host and domain name would be *myhouse.ourlinksys.com*.

**Device Name.** Enter the name you have given the Camera.

Figure 8-15: SoloLink DDNS Screen

Figure 8-16: New User Registration Screen

Figure 8-17: Password Request Screen

**WAN Port.** Enter the number of the port you will use to remotely access the Camera. If you need to find an available port, click **Find Available Port** and follow the on-screen instructions.

**DDNS Service Update.** Depending on how often you want the DDNS service to update the dynamic IP address, select the appropriate time interval from the drop-down menu. To update the dynamic IP address immediately, click the **Update Now** button.

## Status

**Registration Status.** The status of the Camera's registration is displayed here. To use the SoloLink DDNS service for the Camera, it must be registered with your SoloLink DDNS account.

**Address Update Status.** The status of the most recent DDNS service update is displayed here. You will be informed if the username and password authentication has been successful, as well as if the dynamic IP address has been updated.

**Last Update Attempt.** The date and time of the most recent IP address update attempt are displayed here.

**Last Successful Update.** The date and time of the most recent IP address update are displayed here.

**Options.** If you want to manage your SoloLink DDNS account, click the **DDNS Account** button. Your web browser will automatically start up, and you will visit a website to manage your SoloLink account. Follow the on-screen instructions.

If you want to remove the Camera from the DDNS service account, click the **Remove Camera** button. The *Device Removal* screen will appear. To remove the Camera, click the **Remove** button. Click the **Back** button to return to the previous screen.

To save your changes, click the **Apply** button. To cancel any unsaved changes, click the **Cancel** button. To display the most recent information, click the **Refresh** button. To get additional information about the screen's features, click the **Help** tab.

## SoloLink Registration of Additional Cameras

After you have set up your SoloLink account, you can add more Cameras to your account, one at a time. Follow these instructions for each Camera you add:

1. On the *SoloLink DDNS* screen of the Camera's Web-based Utility, enter your SoloLink account information in the *Username*, *Password*, and *Your Domain* fields.
2. In the *Device Name* field, give the Camera a unique name. The DDNS service will not work if multiple Cameras have the same Device Name.



Figure 8-18: SoloLink Screen, continued



Figure 8-19: Manage Your SoloLink DDNS Account



Figure 8-20: Device Removal Screen



## Compact Wireless-G Internet Video Camera

3. In the *WAN Port* field, enter a unique port number. This is the number of the port you will use to access the Camera remotely. If you need to find an available port, click **Find Available Port** and follow the on-screen instructions. The DDNS service will not work if multiple Cameras use the same WAN port.
4. Depending on how often you want the DDNS service to update the dynamic IP address, select the appropriate time interval from the *DDNS Service Update* drop-down menu. To update the dynamic IP address immediately, click the **Update Now** button.
5. Click the **Apply** button on the *SoloLink DDNS* screen. The Camera will automatically register itself with your SoloLink account.
6. Set up port forwarding on your network router, so the SoloLink DDNS Service will be able to track the Compact Wireless-G Internet Video Camera. Go to [www.linksys.com/portfwd](http://www.linksys.com/portfwd) for instructions on how to configure a Linksys router.

For other routers, refer to your router's documentation.



Figure 8-21: Find Available Port Screen



## Options

The *Options* screen allows you to alter the Camera's e-mail alert features, UPnP configuration, and Alternate Port settings.

### E-mail Alert

You can choose to be notified when the Camera detects motion in its field of view. You will be sent a text-only e-mail or an e-mail with video attached.



**NOTE:** The Camera's motion sensitivity and range will vary depending on the light conditions of your environment.

**E-mail Alert.** If you want to be notified by e-mail when the Camera detects motion, then select **Enable** from the drop-down menu. Otherwise, select **Disable**.

**Send to.** In each field, enter an e-mail address that will receive e-mail alerts. (You can enter up to three e-mail addresses.)

**Show "From" as.** Enter the text that you want displayed in the *From* field of any e-mail alert message.

**Subject.** Enter the subject heading that you want to be used.

**Mail SMTP Server.** Enter the IP address of the outgoing mail SMTP server. If it requires authentication, click the checkbox, and enter the account name and password in the *Account Name* and *Password* fields.

**Delay between E-mails.** Specify the minimum time interval between e-mail alerts. The default is 2 minutes.

**E-Mail Video.** If you want e-mail sent with a video attachment, select **Enable** from the drop-down menu. Then select the length of video you want, up to a maximum of 5 seconds. The default is 2 seconds. If you want text-only e-mail sent to you, select **Disable** from the drop-down menu.

**Motion Detection.** To specify where and how the Camera should monitor for motion, click the **Set Area & Sensitivity** button.

Two motion detection areas will be shown in windows labeled Area 1 and Area 2. Use your mouse to move them around to the areas you want the Camera to monitor.

Sections labeled Detected Area 1 and Detected Area 2 show additional settings. For each area, click the checkbox next to *Enable* if you want that area monitored. Then slide the bar left (less sensitive) or right (more sensitive) to adjust the Threshold (sensitivity) level. Click the **Save** button to save your changes.

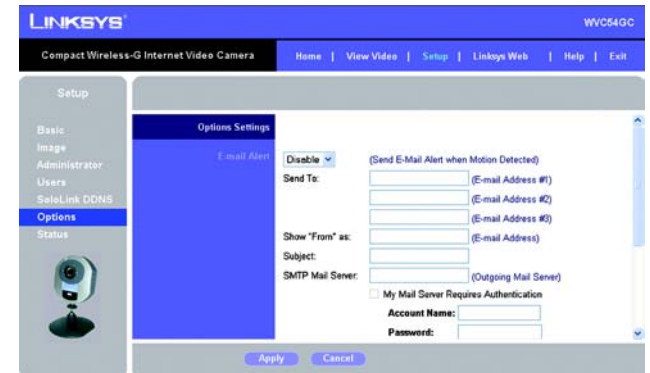

Figure 8-22: Options Screen



Figure 8-23: Options Screen, continued

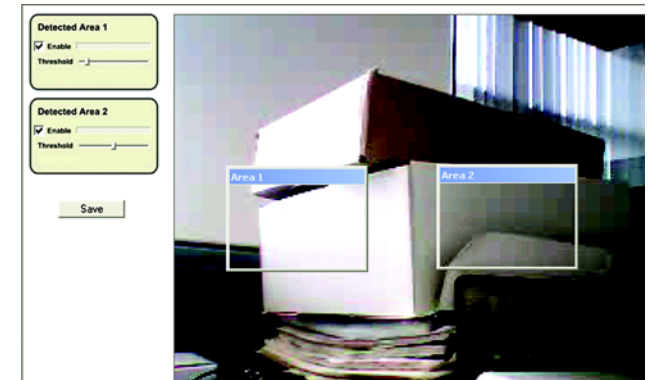

Figure 8-24: Motion Detection Screen

## Other

**UPnP.** When enabled, the Camera's Universal Plug and Play (UPnP) feature allows a UPnP-enabled computer to easily detect the Camera. If your computer is UPnP-enabled, then select **Enable**.

**Alternate Port.** If you want the Camera to be able to use an alternate port for HTTP/web connections, select **Enable**. Then enter the port number you want in the *Port Number* field.

To save your changes, click the **Apply** button. To cancel any unsaved changes, click the **Cancel** button. To get additional information about the screen's features, click the **Help** tab.

## Status

The *Status* screen allows you to view the Camera's status information.

### System Status

**Firmware Version.** The version number of the firmware currently installed is displayed here. Firmware should only be upgraded from the *Help* screen if you experience problems with the Camera. Visit [www.linksys.com](http://www.linksys.com) to find out if there is updated firmware.

**MAC Address.** The MAC Address of the Camera is displayed here.

**Camera Name.** The name you gave to the Camera is displayed here.

**Description.** The information about the Camera that you entered is displayed here.

**Date/Time.** The current date and time are shown here.

### Network

**Network Type.** The type of network is shown here.

**IP Address.** The Camera's IP Address is displayed here.

**Subnet Mask.** The Camera's Subnet Mask is shown here.

**Gateway.** The IP address of the Camera's Gateway is displayed here.

### Wireless

**SSID.** The SSID or wireless network name of the Camera is shown here.

**Channel.** The channel setting of the Camera is displayed here.

**Security.** The wireless security setting of the Camera is shown here.

To get the Camera's most up-to-date information, click the **Refresh** button. To get additional information about the screen's features, click the **Help** tab.



Figure 8-25: Status Screen

## Help

Through the *Help* screen, you'll find links to additional resources for the Camera and its Utility. If you click the Help tab directly from the *Welcome* screen, then you will see the *User Help* screen and will only be able to access the link to the Linksys support page for downloading the latest Multi-Camera Viewer & Recorder Utility, as well as view information about the View Video feature.



**NOTE:** The appearance and features of the *Help* screen will vary depending on whether you have logged in first to access the Setup.

If you first log in to access the Camera's Setup and then click the Help tab, you will see the *Administrator Help* screen and will be able to access these resources:

**Setup.** Click any of the topics in the bar on the left to get help information.

**Linksys Support Page - Download Latest Viewer/Recorder Utility.** Click this link to download the most recent version of the Multi-Camera Viewer & Recorder Utility from the Linksys website, [www.linksys.com](http://www.linksys.com).

**Click here to learn how to configure Port Forwarding in your Linksys Router.** If you are going to use the SoloLink DDNS Service, you need to set up port forwarding on your router. For instructions on how to configure a Linksys router, click this link. If you have a different router, refer to your router's documentation.

**Adobe website (software for viewing PDF documents).** If you do not have the Acrobat Reader, click the **Adobe website** link to download it.

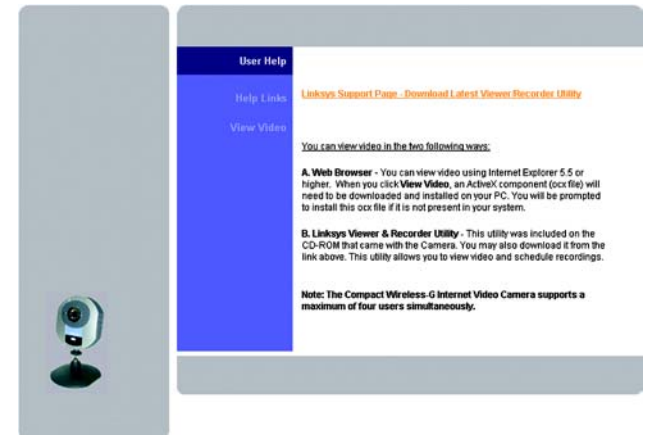

Figure 8-26: User Help Screen

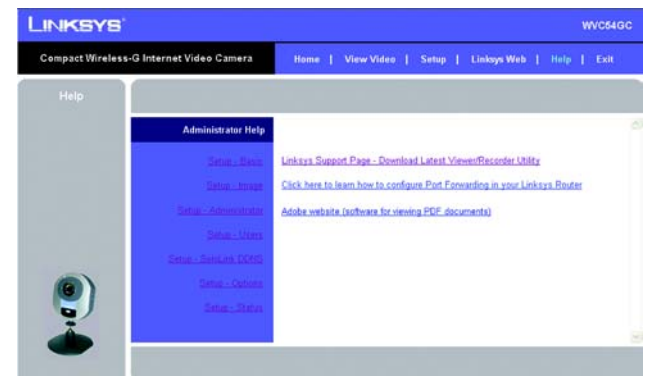

Figure 8-27: Administrator Help Screen

# Appendix A: Troubleshooting

This appendix consists of two parts: “Common Problems and Solutions” and “Frequently Asked Questions.” This appendix provides solutions to problems that may occur during the installation and operation of the Compact Wireless-G Internet Video Camera. Read the description below to solve your problems. If you can't find an answer here, check the Linksys website at [www.linksys.com](http://www.linksys.com).

## Common Problems and Solutions

### 1. *I can't view the Camera's video using Internet Explorer.*

Make sure the OCX plug-in was correctly installed. If you're not sure, re-install the plug-in by following these instructions:

- On the *Welcome* screen of the Camera's Web-based Utility, click the **View Video** button.
- A screen mentioning a security warning about an OCX plug-in will appear. Click the **Yes** button to allow the plug-in to be installed.
- You should then be able to view the Camera's streaming video.

If you still cannot view the video, make sure you have the rights to install the plug-in in your PC's Internet Explorer. If not, log into your computer as an administrator and install the plug-in.

Then you can check if the OCX plug-in has been installed. Follow these instructions:

- From Internet Explorer, go to **Tools** and **Internet Options**.
- On the General screen, click **Settings** under *Temporary Internet files*.
- Click **View Objects**. You should see a file named NetCamPlayerWeb Control installed.

### 2. *The OCX plug-in is installed in Internet Explorer, but I cannot view any video.*

Make sure you have Microsoft Internet Explorer 5.5 or higher installed. Then delete the OCX plug-in by following these instructions:

- From Internet Explorer, go to **Tools** and **Internet Options**.
- On the General screen, click **Settings** under *Temporary Internet files*.
- Click **View Objects**.
- You should see a file named NetCamPlayerWeb Control installed. Delete this file from the list.
- The next time you click View Video from the web browser, you will be prompted to re-install the OCX plug-in.

### 3. *When powering on the Camera, I can't immediately access the Camera from my computer.*

Make sure the Camera's LED is continuously lit. When it is flashing, the Camera is initializing.

**4. I'm not able to play my recording video files.**

Make sure you have Microsoft Windows Media Player 7 or higher. If you don't, you can download the latest version from [www.microsoft.com](http://www.microsoft.com).

**5. I have two Cameras and see two WVC54GCs listed in my Multi-Camera Viewer & Recorder Utility. When I click to view both Cameras, I see the video of only one Camera.**

Make sure that the Cameras have different camera or device names. You can change this by using the Web-based Utility or running the Setup Wizard. If you use the Web-based Utility, log in and click the **Setup** tab. Then on the *Basic* screen, change the Camera Name.

**6. I want to set up an account with the SoloLink DDNS Service, but I can't access the SoloLink website to sign up.**

Make sure the Camera is properly configured on your local network. Then check to see if your PC and Camera are properly connected and your network has an active Internet connection.

**7. When I view video remotely via the Internet, the video is very slow.**

Video performance is greatly affected by your Internet connection speed. You can lower the Camera's image quality to speed up the video. Through the Camera's Web-based Utility, click the **Setup** and **Image** tabs, and then lower the image quality on the *Image* screen.

**8. I cannot access the Setup tab of the Camera's Web-based Utility.**

Make sure you have administrator rights. Only an administrator can change the Camera's settings.

**9. I want to access the Camera when I'm away from home, but somehow I can't connect.**

If your network uses a dynamic IP address supplied by your ISP, then the IP address you use to reach the Camera will change as well. You need to use the Linksys SoloLink DDNS Service, so you can access the Camera using its domain name while the service keeps track of the IP address changes. To set up a Dynamic Domain Name Service (DDNS) account, click the **Setup** tab of the Camera's Web-based Utility. Click the **SoloLink DDNS** tab. If you are a new user, click **New User? - Click here to Register**. Follow the on-screen instructions.

You can also set up the Linksys SoloLink DDNS Service by inserting the Setup CD-ROM into your PC's CD-ROM drive. Click the **Setup SoloLink DDNS Service** button, and follow the on-screen instructions. For more information, see "Chapter 7: Setting up the Linksys SoloLink DDNS Service."

Important: To allow remote access to the Camera, you will also have to use the port forwarding feature on your network router.

**10. I already set up my SoloLink DDNS account, but I can't access the Camera from a remote location.**

Follow these instructions:

- When you enter the Camera's domain name, make sure it is in this format:  
**http://<Device Name>.<Location ID>.ourlinksys.com**  
The <Device Name> is the name you gave the Camera when you ran the Setup Wizard. The <Location ID> is the name you selected when you set up your SoloLink DDNS account.
- If the Camera is set to DHCP, make sure your local network is working properly and your router has an active Internet connection.
- If the Camera uses a static IP address, insert the Setup CD-ROM into your network PC's CD-ROM drive. Click the **Setup** button and follow the on-screen instructions. When you see the *IP Settings* screen, make sure the Camera's Default Gateway and Primary DNS addresses are correct. For more information, refer to "Chapter 5: Setting up and Mounting the Compact Wireless-G Internet Video Camera."

## Frequently Asked Questions

***Can I view video using a Macintosh or Netscape Navigator?***

The Camera is designed for computers running a Windows operating system and Internet Explorer 5.5 or higher. You cannot view video on a Macintosh. If you only have Netscape, you can view video using the Multi-Camera Viewer & Recorder Utility. See "Chapter 6: Installing and Using the Compact Wireless-G Internet Video Camera Multi-Camera Viewer & Recorder Utility."

***Can I directly connect the Camera to wired and wireless networks at the same time?***

No. Before powering on the Camera, you should decide if you want to connect the Camera to a wireless network via an access point or to a wired network. If your wireless and wired networks are bridged, then you can access the Camera from any networked computer, but the Camera must be directly connected to only one of the networks.

To connect the Camera to a wireless network, power on the Camera with no network cable attached. The Camera will be ready for use when the LED is lit continuously.

To connect the Camera to a wired network, connect the network cable to the Camera, and then power it on. The Camera will be ready for use when the LED is lit continuously.

***Can I install the Camera outdoors?***

No, the Camera was not designed for outdoors usage.

***I've recorded video for a few hours. Why do I see multiple files saved on my computer?***

The recording function saves video in chunks; each chunk is a maximum of one hour in duration. For example, if you have recorded five continuous hours, then you will see five files saved on your computer. This keeps files from getting too large.

***Do I need to install the Linksys Multi-Camera Viewer and Recorder Utility?***

Installation is optional. You can view video using Microsoft Internet Explorer 5.5 or higher. If you don't want to use the recording function, then you don't need to install the Multi-Camera Viewer and Recorder Utility.

***Where can I find more information about the Linksys SoloLink DDNS Service?***

You can go to [www.linksys.com/sololink](http://www.linksys.com/sololink) for more information.

***Can I specify who gets to view the Camera's video?***

Yes. Access the Camera's Web-based Utility, and click the **Setup** tab. After you log in, click the **Users** tab. You will be able to restrict access to users you have entered in the database. See "Chapter 8: Using the Compact Wireless-G Internet Video Camera Web-based Utility."

***Can I add a time stamp to the video?***

Yes. Access the Camera's Web-based Utility, and click the **Setup** tab. After you log in, click the **Image** tab. You will be able to add a time stamp as well as descriptive text to the video. See "Chapter 8: Using the Compact Wireless-G Internet Video Camera Web-based Utility."

***How many users can view the Camera's video at the same time?***

Users at four different PCs can simultaneously view the Camera's video.

***What is the IEEE 802.11b standard?***

It is one of the IEEE standards for wireless networks. The 802.11b standard allows wireless networking hardware from different manufacturers to communicate, provided that the hardware complies with the 802.11b standard. The 802.11b standard states a maximum data transfer rate of 11Mbps and an operating frequency of 2.4GHz.

***What is the IEEE 802.11g standard?***

It is one of the IEEE standards for wireless networks. The 802.11g standard allows wireless networking hardware from different manufacturers to communicate, provided that the hardware complies with the 802.11g standard. The 802.11g standard states a maximum data transfer rate of 54Mbps and an operating frequency of 2.4GHz.

***What IEEE 802.11b features are supported?***

The product supports the following IEEE 802.11b functions:

- CSMA/CA plus Acknowledge protocol
- Multi-Channel Roaming
- Automatic Rate Selection
- RTS/CTS feature
- Fragmentation
- Power Management



***What IEEE 802.11g features are supported?***

The product supports the following IEEE 802.11g functions:

- CSMA/CA plus Acknowledge protocol
- OFDM protocol
- Multi-Channel Roaming
- Automatic Rate Selection
- RTS/CTS feature
- Fragmentation
- Power Management

***What is ad-hoc mode?***

When a wireless network is set to ad-hoc mode, the wireless-equipped computers are configured to communicate directly with each other. The ad-hoc wireless network will not communicate with any wired network.

***What is infrastructure mode?***

When a wireless network is set to infrastructure mode, the wireless network is configured to communicate with a wired network through a wireless access point or router.

# Appendix B: Wireless Security

Linksys wants to make wireless networking as safe and easy for you as possible. The current generation of Linksys products provide several network security features, but they require specific action on your part for implementation. So, keep the following in mind whenever you are setting up or using your wireless network.

## Security Precautions

The following is a complete list of security precautions to take (at least steps 1 through 5 should be followed):

1. Change the default SSID.
2. Disable SSID Broadcast.
3. Change the default password for the Administrator account.
4. Enable MAC Address Filtering.
5. Change the SSID periodically.
6. Use the highest encryption algorithm possible. Use WPA if it is available. Please note that this may reduce your network performance.
7. Change the encryption keys periodically.



**NOTE:** Some of these security features are available only through the network router or access point. Refer to the router or access point's documentation for more information.

## Security Threats Facing Wireless Networks

Wireless networks are easy to find. Hackers know that in order to join a wireless network, wireless networking products first listen for "beacon messages". These messages can be easily decrypted and contain much of the network's information, such as the network's SSID (Service Set Identifier). Here are the steps you can take:

**Change the administrator's password regularly.** With every wireless networking device you use, keep in mind that network settings (SSID, WEP keys, etc.) are stored in its firmware. Your network administrator is the only person who can change network settings. If a hacker gets a hold of the administrator's password, he, too, can change those settings. So, make it harder for a hacker to get that information. Change the administrator's password regularly.

**SSID.** There are several things to keep in mind about the SSID:

1. Disable Broadcast
2. Make it unique
3. Change it often

Most wireless networking devices will give you the option of broadcasting the SSID. While this option may be more convenient, it allows anyone to log into your wireless network. This includes hackers. So, don't broadcast the SSID.

Wireless networking products come with a default SSID set by the factory. (The Linksys default SSID is "linksys".) Hackers know these defaults and can check these against your network. Change your SSID to something unique and not something related to your company or the networking products you use.

Change your SSID regularly so that any hackers who have gained access to your wireless network will have to start from the beginning in trying to break in.

**MAC Addresses.** Enable MAC Address filtering. MAC Address filtering will allow you to provide access to only those wireless nodes with certain MAC Addresses. This makes it harder for a hacker to access your network with a random MAC Address.

**WEP Encryption.** Wired Equivalent Privacy (WEP) is often looked upon as a cure-all for wireless security concerns. This is overstating WEP's ability. Again, this can only provide enough security to make a hacker's job more difficult.

There are several ways that WEP can be maximized:

1. Use the highest level of encryption possible
2. Use "Shared Key" authentication
3. Change your WEP key regularly

**WPA.** Wi-Fi Protected Access (WPA) is the newest and best available standard in Wi-Fi security. For encryption, WPA Personal automatically uses Temporal Key Integrity Protocol (TKIP), which incorporates Message Integrity Code (MIC) to provide protection against hackers. For the *Passphrase* field, enter the key shared by the devices on your wireless network. (This key should have 8-63 characters and can also be called a WPA shared key or pre-shared key.)



**IMPORTANT:** Always remember that each device in your wireless network **MUST** use the same encryption method and encryption key or your wireless network will not function properly.

#### Compact Wireless-G Internet Video Camera

Implementing encryption may have a negative impact on your network's performance, but if you are transmitting sensitive data over your network, encryption should be used.

These security recommendations should help keep your mind at ease while you are enjoying the most flexible and convenient technology Linksys has to offer.

# Appendix C: Upgrading Firmware



**NOTE:** Linksys recommends that you upgrade the Camera's firmware within your network; in other words, use a computer within the Camera's local network. If you attempt to upgrade the Camera's firmware from a remote location—using a computer outside of the Camera's local network—the upgrade will fail.

The Camera's firmware is upgraded through the Web-based Utility's Administrator tab. Follow these instructions:

To upgrade the firmware, follow these instructions:

1. Go to *www.linksys.com* and download the firmware upgrade file for the Camera. Then extract the file.
2. Click the **Upgrade Firmware** button on the *Administrator* screen.
3. On the *Upgrade Firmware* screen, click the **Browse** button to find the extracted file, and then double-click it.
4. Click the **Start Upgrade** button, and follow the on-screen instructions. To cancel the upgrade, click the **Cancel** button. For further help, click the **Help** tab.



Figure C-1: Upgrade Firmware Screen

# Appendix D: Windows Help

Almost all wireless products require Microsoft Windows. Windows is the most used operating system in the world and comes with many features that help make networking easier. These features can be accessed through Windows Help and are described in this appendix.

## TCP/IP

Before a computer can communicate with an access point or router, TCP/IP must be enabled. TCP/IP is a set of instructions, or protocol, all PCs follow to communicate over a network. This is true for wireless networks as well. Your PCs will not be able to utilize wireless networking without having TCP/IP enabled. Windows Help provides complete instructions on enabling TCP/IP.

## Shared Resources

If you wish to share printers, folders, or files over your network, Windows Help provides complete instructions on using shared resources.

## Network Neighborhood/My Network Places

Other PCs on your network will appear under Network Neighborhood or My Network Places (depending upon the version of Windows you're running). Windows Help provides complete instructions on adding PCs to your network.

# Appendix E: Glossary

**802.11b** - An IEEE wireless networking standard that specifies a maximum data transfer rate of 11Mbps and an operating frequency of 2.4GHz.

**802.11g** - An IEEE wireless networking standard that specifies a maximum data transfer rate of 54Mbps, an operating frequency of 2.4GHz, and backward compatibility with 802.11b devices.

**Access Point** - A device that allows wireless-equipped computers and other devices to communicate with a wired network. Also used to expand the range of a wireless network.

**Adapter** - A device that adds network functionality to your PC.

**Ad-hoc** - A group of wireless devices communicating directly with each other (peer-to-peer) without the use of an access point.

**Backbone** - The part of a network that connects most of the systems and networks together, and handles the most data.

**Bandwidth** - The transmission capacity of a given device or network.

**Beacon Interval** - Data transmitted on your wireless network that keeps the network synchronized.

**Bit** - A binary digit.

**Boot** - To start a device and cause it to start executing instructions.

**Bridge** - A device that connects different networks.

**Broadband** - An always-on, fast Internet connection.

**Browser** - An application program that provides a way to look at and interact with all the information on the World Wide Web.

**Buffer** - A shared or assigned memory area that is used to support and coordinate different computing and networking activities so one isn't held up by the other.

**Byte** - A unit of data that is usually eight bits long

## Compact Wireless-G Internet Video Camera

**Cable Modem** - A device that connects a computer to the cable television network, which in turn connects to the Internet.

**CSMA/CA (Carrier Sense Multiple Access/Collision Avoidance)** - A method of data transfer that is used to prevent data collisions.

**CTS (Clear To Send)** - A signal sent by a wireless device, signifying that it is ready to receive data.

**Daisy Chain** - A method used to connect devices in a series, one after the other.

**Database** - A collection of data that is organized so that its contents can easily be accessed, managed, and updated.

**DDNS (Dynamic Domain Name System)** - Allows the hosting of a website, FTP server, or e-mail server with a fixed domain name (e.g., www.xyz.com) and a dynamic IP address.

**Default Gateway** - A device that forwards Internet traffic from your local area network.

**DHCP (Dynamic Host Configuration Protocol)** - A networking protocol that allows administrators to assign temporary IP addresses to network computers by "leasing" an IP address to a user for a limited amount of time, instead of assigning permanent IP addresses.

**DMZ (Demilitarized Zone)** - Removes the Router's firewall protection from one PC, allowing it to be "seen" from the Internet.

**DNS (Domain Name Server)** - The IP address of your ISP's server, which translates the names of websites into IP addresses.

**Domain** - A specific name for a network of computers.

**Download** - To receive a file transmitted over a network.

**DSL (Digital Subscriber Line)** - An always-on broadband connection over traditional phone lines.

**DSSS (Direct-Sequence Spread-Spectrum)** - Frequency transmission with a redundant bit pattern resulting in a lower probability of information being lost in transit.

**DTIM (Delivery Traffic Indication Message)** - A message included in data packets that can increase wireless efficiency.

**Dynamic IP Address** - A temporary IP address assigned by a DHCP server.



**Encryption** - Encoding data transmitted in a network.

**Ethernet** - IEEE standard network protocol that specifies how data is placed on and retrieved from a common transmission medium.

**Finger** - A program that tells you the name associated with an e-mail address.

**Firewall** - A set of related programs located at a network gateway server that protects the resources of a network from users from other networks.

**Firmware** - The programming code that runs a networking device.

**Fragmentation** - Breaking a packet into smaller units when transmitting over a network medium that cannot support the original size of the packet.

**FTP (File Transfer Protocol)** - A protocol used to transfer files over a TCP/IP network.

**Full Duplex** - The ability of a networking device to receive and transmit data simultaneously.

**Gateway** - A device that interconnects networks with different, incompatible communications protocols.

**Half Duplex** - Data transmission that can occur in two directions over a single line, but only one direction at a time.

**Hardware** - The physical aspect of computers, telecommunications, and other information technology devices.

**HTTP (HyperText Transport Protocol)** - The communications protocol used to connect to servers on the World Wide Web.

**IEEE (The Institute of Electrical and Electronics Engineers)** - An independent institute that develops networking standards.

**Infrastructure** - A wireless network that is bridged to a wired network via an access point.

**IP (Internet Protocol)** - A protocol used to send data over a network.

**IP Address** - The address used to identify a computer or device on a network.

**IPCONFIG** - A Windows 2000 and XP utility that displays the IP address for a particular networking device.

**ISM band** - Radio bandwidth utilized in wireless transmissions.

**ISP (Internet Service Provider)** - A company that provides access to the Internet.

**LAN** - The computers and networking products that make up your local network.

**MAC (Media Access Control) Address** - The unique address that a manufacturer assigns to each networking device.

**Mbps (MegaBits Per Second)** - One million bits per second; a unit of measurement for data transmission.

**mIRC** - An Internet Relay Chat program that runs under Windows.

**Multicasting** - Sending data to a group of destinations at once.

**NAT (Network Address Translation)** - NAT technology translates IP addresses of a local area network to a different IP address for the Internet.

**Network** - A series of computers or devices connected for the purpose of data sharing, storage, and/or transmission between users.

**NNTP (Network News Transfer Protocol)** - The protocol used to connect to Usenet groups on the Internet.

**Node** - A network junction or connection point, typically a computer or work station.

**OFDM (Orthogonal Frequency Division Multiplexing)** - Frequency transmission that separates the data stream into a number of lower-speed data streams, which are then transmitted in parallel to prevent information from being lost in transit.

**Packet** - A unit of data sent over a network.

**Passphrase** - Used much like a password, a passphrase simplifies the WEP encryption process by automatically generating the WEP encryption keys for Linksys products.

**Ping (Packet INternet Groper)** - An Internet utility used to determine whether a particular IP address is online.

**POP3 (Post Office Protocol 3)** - A standard mail server commonly used on the Internet.

**Port** - The connection point on a computer or networking device used for plugging in cables or adapters.

**Power over Ethernet (PoE)** - A technology enabling an Ethernet network cable to deliver both data and power.

**PPPoE (Point to Point Protocol over Ethernet)** - A type of broadband connection that provides authentication (username and password) in addition to data transport.

**PPTP (Point-to-Point Tunneling Protocol)** - A VPN protocol that allows the Point to Point Protocol (PPP) to be tunneled through an IP network. This protocol is also used as a type of broadband connection in Europe.

## Compact Wireless-G Internet Video Camera

**Preamble** - Part of the wireless signal that synchronizes network traffic.

**RJ-45 (Registered Jack-45)** - An Ethernet connector that holds up to eight wires.

**Roaming** - The ability to take a wireless device from one access point's range to another without losing the connection.

**Router** - A networking device that connects multiple networks together.

**RTS (Request To Send)** - A networking method of coordinating large packets through the RTS Threshold setting.

**Server** - Any computer whose function in a network is to provide user access to files, printing, communications, and other services.

**SMTP (Simple Mail Transfer Protocol)** - The standard e-mail protocol on the Internet.

**SNMP (Simple Network Management Protocol)** - A widely used network monitoring and control protocol.

**Software** - Instructions for the computer. A series of instructions that performs a particular task is called a "program".

**SOHO (Small Office/Home Office)** - Market segment of professionals who work at home or in small offices.

**SPI (Stateful Packet Inspection) Firewall** - A technology that inspects incoming packets of information before allowing them to enter the network.

**Spread Spectrum** - Wideband radio frequency technique used for more reliable and secure data transmission.

**SSID (Service Set Identifier)** - Your wireless network's name.

**Static IP Address** - A fixed address assigned to a computer or device that is connected to a network.

**Static Routing** - Forwarding data in a network via a fixed path.

**Subnet Mask** - An address code that determines the size of the network.

**Switch** - 1. A data switch that connects computing devices to host computers, allowing a large number of devices to share a limited number of ports. 2. A device for making, breaking, or changing the connections in an electrical circuit.

**TCP (Transmission Control Protocol)** - A network protocol for transmitting data that requires acknowledgement from the recipient of data sent.

## Compact Wireless-G Internet Video Camera

**TCP/IP (Transmission Control Protocol/Internet Protocol)** - A set of instructions PCs use to communicate over a network.

**Telnet** - A user command and TCP/IP protocol used for accessing remote PCs.

**TFTP (Trivial File Transfer Protocol)** - A version of the TCP/IP FTP protocol that has no directory or password capability.

**Throughput** - The amount of data moved successfully from one node to another in a given time period.

**TKIP (Temporal Key Integrity Protocol)** - a wireless encryption protocol that provides dynamic encryption keys for each packet transmitted.

**Topology** - The physical layout of a network.

**TX Rate** - Transmission Rate.

**UDP (User Datagram Protocol)** - A network protocol for transmitting data that does not require acknowledgement from the recipient of the data that is sent.

**Upgrade** - To replace existing software or firmware with a newer version.

**Upload** - To transmit a file over a network.

**URL (Uniform Resource Locator)** - The address of a file located on the Internet.

**VPN (Virtual Private Network)** - A security measure to protect data as it leaves one network and goes to another over the Internet.

**WAN (Wide Area Network)**- The Internet.

**WEP (Wired Equivalent Privacy)** - A method of encrypting network data transmitted on a wireless network for greater security.

**WINIPCFG** - A Windows 98 and Me utility that displays the IP address for a particular networking device.

**WLAN (Wireless Local Area Network)** - A group of computers and associated devices that communicate with each other wirelessly.

**WPA (Wi-Fi Protected Access)** - a wireless security protocol using TKIP (Temporal Key Integrity Protocol) encryption, which can be used in conjunction with a RADIUS server.

# Appendix F: Specifications

Standards	IEEE 802.11b, IEEE 802.11g, IEEE 802.3, IEEE 802.3u
Ports	One 10/100 Auto Crossover (MDI/MDI-X) port, Power port
Protocols	TCP/IP, HTTP, DHCP, NTP, SMTP, UPnP (Discovery only)
Button	One Reset Button
Cabling Type	RJ-45
Indicators	1 x LED
Security Features	User Authentication, WEP/WPA-PSK, Motion Detection
WEP Key Bits	64/128 Bit
Image Sensor	CMOS
Lens	Fixed Focus
Resolution	320 x 240, 160 x 128
Relative Illumination	5.1 Lux
Effective Focus	3 mm
Sensitivity	1.0V/Lux-sec
Field of View	61.48 degrees
Compression Algorithm	MPEG-4

#### Compact Wireless-G Internet Video Camera

Record File Format	ASF
Brightness	Auto/Manual Adjustment
Dimensions (W x H x D)	3.54" x 4.02" x 1.46" (90 mm x 102 mm x 37 mm)
Unit Weight	0.29 lbs. (0.13 kg)
Power	5V DC External
Certifications	FCC
Operating Temp.	0°C to 40°C (32°F to 104°F)
Storage Temp.	-10°C to 70°C (14°F to 158°F)
Operating Humidity	10 to 85%
Storage Humidity	5 to 90%
Warranty	3-year limited

# Appendix G: Warranty Information

## LIMITED WARRANTY

Linksys warrants to You that, for a period of three years (the "Warranty Period"), your Linksys Product will be substantially free of defects in materials and workmanship under normal use. Your exclusive remedy and Linksys' entire liability under this warranty will be for Linksys at its option to repair or replace the Product or refund Your purchase price less any rebates. This limited warranty extends only to the original purchaser.

If the Product proves defective during the Warranty Period call Linksys Technical Support in order to obtain a Return Authorization Number, if applicable. BE SURE TO HAVE YOUR PROOF OF PURCHASE ON HAND WHEN CALLING. If You are requested to return the Product, mark the Return Authorization Number clearly on the outside of the package and include a copy of your original proof of purchase. RETURN REQUESTS CANNOT BE PROCESSED WITHOUT PROOF OF PURCHASE. You are responsible for shipping defective Products to Linksys. Linksys pays for UPS Ground shipping from Linksys back to You only. Customers located outside of the United States of America and Canada are responsible for all shipping and handling charges.

ALL IMPLIED WARRANTIES AND CONDITIONS OF MERCHANTABILITY OR FITNESS FOR A PARTICULAR PURPOSE ARE LIMITED TO THE DURATION OF THE WARRANTY PERIOD. ALL OTHER EXPRESS OR IMPLIED CONDITIONS, REPRESENTATIONS AND WARRANTIES, INCLUDING ANY IMPLIED WARRANTY OF NON-INFRINGEMENT, ARE DISCLAIMED. Some jurisdictions do not allow limitations on how long an implied warranty lasts, so the above limitation may not apply to You. This warranty gives You specific legal rights, and You may also have other rights which vary by jurisdiction.

This warranty does not apply if the Product (a) has been altered, except by Linksys, (b) has not been installed, operated, repaired, or maintained in accordance with instructions supplied by Linksys, or (c) has been subjected to abnormal physical or electrical stress, misuse, negligence, or accident. In addition, due to the continual development of new techniques for intruding upon and attacking networks, Linksys does not warrant that the Product will be free of vulnerability to intrusion or attack.

TO THE EXTENT NOT PROHIBITED BY LAW, IN NO EVENT WILL LINKSYS BE LIABLE FOR ANY LOST DATA, REVENUE OR PROFIT, OR FOR SPECIAL, INDIRECT, CONSEQUENTIAL, INCIDENTAL OR PUNITIVE DAMAGES, REGARDLESS OF THE THEORY OF LIABILITY (INCLUDING NEGLIGENCE), ARISING OUT OF OR RELATED TO THE USE OF OR INABILITY TO USE THE PRODUCT (INCLUDING ANY SOFTWARE), EVEN IF LINKSYS HAS BEEN ADVISED OF THE POSSIBILITY OF SUCH DAMAGES. IN NO EVENT WILL LINKSYS' LIABILITY EXCEED THE AMOUNT PAID BY YOU FOR THE PRODUCT. The foregoing limitations will apply even if any warranty or remedy provided under this Agreement fails of its essential purpose. Some jurisdictions do not allow the exclusion or limitation of incidental or consequential damages, so the above limitation or exclusion may not apply to You.

Please direct all inquiries to: Linksys, P.O. Box 18558, Irvine, CA 92623.

# Appendix H: Regulatory Information

## Federal Communication Commission Interference Statement

This equipment has been tested and found to comply with the limits for a Class B digital device, pursuant to Part 15 of the FCC Rules. These limits are designed to provide reasonable protection against harmful interference in a residential installation. This equipment generates, uses and can radiate radio frequency energy and, if not installed and used in accordance with the instructions, may cause harmful interference to radio communications. However, there is no guarantee that interference will not occur in a particular installation. If this equipment does cause harmful interference to radio or television reception, which can be determined by turning the equipment off and on, the user is encouraged to try to correct the interference by one of the following measures:

- Reorient or relocate the receiving antenna.
- Increase the separation between the equipment and receiver.
- Connect the equipment into an outlet on a circuit different from that to which the receiver is connected.
- Consult the dealer or an experienced radio/TV technician for help.

This device complies with Part 15 of the FCC Rules. Operation is subject to the following two conditions: (1) This device may not cause harmful interference, and (2) this device must accept any interference received, including interference that may cause undesired operation.

FCC Caution: Any changes or modifications not expressly approved by the party responsible for compliance could void the user's authority to operate this equipment.

## IMPORTANT NOTE: FCC Radiation Exposure Statement

This equipment complies with FCC radiation exposure limits set forth for an uncontrolled environment. This equipment should be installed and operated with minimum distance 20cm between the radiator & your body. To maintain compliance with FCC RF exposure compliance requirements, please avoid direct contact to the transmitting antenna during transmitting.

This transmitter must not be co-located or operating in conjunction with any other antenna or transmitter.

We declare that the product is limited in CH1-CH11 by specified firmware controlled in the USA.



## INDUSTRY CANADA

The use of this device in a system operating either partially or completely outdoors may require the user to obtain a license for the system according to the Canadian regulations.

This device complies with Industry Canada ICES-003 and RSS210 rules.

### IC Statement

Operation is subject to the following two conditions:

1. This device may not cause interference and
2. This device must accept any interference, including interference that may cause undesired operation of the device.

L'utilisation de ce périphérique dans un système utilisé partiellement ou totalement en extérieur peut conduire l'utilisateur à l'obtention d'une licence pour ce système conformément aux règles en vigueur au Canada.

Cet appareil est conforme aux normes NMB-003 et RSS210 d'Industrie Canada.

### Déclaration d'Industrie Canada

Le fonctionnement est soumis aux conditions suivantes :

1. Ce périphérique ne doit pas causer d'interférences;
2. Ce périphérique doit accepter toutes les interférences reçues, y compris celles qui risquent d'entraîner un fonctionnement indésirable.

## SAFETY NOTICES

Caution: To reduce the risk of fire, use only No.26 AWG or larger telecommunication line cord.

Do not use this product near water, for example, in a wet basement or near a swimming pool.

Avoid using this product during an electrical storm. There may be a remote risk of electric shock from lightning.

## SOFTWARE LICENSE AGREEMENT

THIS LICENSE AGREEMENT IS BETWEEN YOU AND CISCO-LINKSYS, LLC (“Linksys”). BY DOWNLOADING OR INSTALLING THE SOFTWARE, OR USING THE PRODUCT CONTAINING THE SOFTWARE, YOU ARE CONSENTING TO BE BOUND BY THIS AGREEMENT. IF YOU DO NOT AGREE TO ALL OF THESE TERMS, THEN YOU MAY NOT DOWNLOAD, INSTALL OR USE THE SOFTWARE. YOU MAY RETURN UNUSED SOFTWARE (OR, IF THE SOFTWARE IS SUPPLIED AS PART OF ANOTHER PRODUCT, THE UNUSED PRODUCT) FOR A FULL REFUND UP TO 30 DAYS AFTER ORIGINAL PURCHASE.

**License.** Subject to the terms and conditions of this Agreement, Linksys grants the original end user purchaser of the Linksys product containing the Software (“You”) a nonexclusive license to use the Software solely as embedded in or (where authorized in the applicable documentation) for communication with such product. This license may not be sublicensed, and is not transferable except to a person or entity to whom you transfer ownership of the complete Linksys product containing the Software, provided you permanently transfer all rights under this Agreement and do not retain any full or partial copies of the Software, and the recipient agrees to the terms of this Agreement.

“Software” includes, and this Agreement will apply to (a) the Linksys software provided in or with the applicable Linksys product, and (b) any upgrades, updates, bug fixes or modified versions (“Upgrades”) or backup copies of the Software supplied to You by Linksys or an authorized reseller, provided you already hold a valid license to the original software and have paid any applicable fee for the Upgrade.

**Protection of Information.** The Software and documentation contain trade secrets and/or copyrighted materials of Linksys or its suppliers. You will not decompile, decrypt, reverse engineer or disassemble the Software (except to the extent expressly permitted by law notwithstanding this provision), and will not disclose or make available such trade secrets or copyrighted material in any form to any third party. Title to Software and documentation will remain solely with Linksys.

**Open Source Software.** The GPL source code incorporated into this product is available for free download at <http://www.linksys.com/gpl>. If You would like a copy of the GPL source code in this product on a CD, Linksys will copy and mail to You a CD with the code for \$9.99 plus the cost of shipping upon request.

**Term and Termination.** You may terminate this License at any time by destroying all copies of the Software and documentation. Your rights under this License will terminate immediately without notice from Linksys if You fail to comply with any provision of this Agreement.

**Limited Warranty.** The warranty terms and period specified in the applicable Linksys Product User Guide shall also apply to the Software.

**Disclaimer of Liabilities.** IN NO EVENT WILL LINKSYS BE LIABLE FOR ANY LOST DATA, REVENUE OR PROFIT, OR FOR SPECIAL, INDIRECT, CONSEQUENTIAL, INCIDENTAL OR PUNITIVE DAMAGES, REGARDLESS OF CAUSE

## Compact Wireless-G Internet Video Camera

(INCLUDING NEGLIGENCE), ARISING OUT OF OR RELATED TO THE USE OF OR INABILITY TO USE THE SOFTWARE, EVEN IF LINKSYS HAS BEEN ADVISED OF THE POSSIBILITY OF SUCH DAMAGES. IN NO EVENT WILL LINKSYS' LIABILITY EXCEED THE AMOUNT PAID BY YOU FOR THE PRODUCT. The foregoing limitations will apply even if any warranty or remedy under this Agreement fails of its essential purpose. Some jurisdictions do not allow the exclusion or limitation of incidental or consequential damages, so the above limitation or exclusion may not apply to You.

**Export.** Software, including technical data, may be subject to U.S. export control laws and regulations and/or export or import regulations in other countries. You agree to comply strictly with all such laws and regulations.

**U.S. Government Users.** The Software and documentation qualify as "commercial items" as defined at 48 C.F.R. 2.101 and 48 C.F.R. 12.212. All Government users acquire the Software and documentation with only those rights herein that apply to non-governmental customers.

**General Terms.** This Agreement will be governed by and construed in accordance with the laws of the State of California, without reference to conflict of laws principles. The United Nations Convention on Contracts for the International Sale of Goods will not apply. If any portion of this Agreement is found to be void or unenforceable, the remaining provisions will remain in full force and effect. This Agreement constitutes the entire agreement between the parties with respect to the Software and supersedes any conflicting or additional terms contained in any purchase order or elsewhere.

# Appendix I: Contact Information

Need to contact Linksys?

Visit us online for information on the latest products and updates to your existing products at:

<http://www.linksys.com> or  
[ftp.linksys.com](ftp://ftp.linksys.com)

Can't find information about a product you want to buy on the web? Do you want to know more about networking with Linksys products? Give our advice line a call at:  
Or fax your request in to:

800-546-5797 (LINKSYS)  
949-823-3002

If you experience problems with any Linksys product, you can call us at:  
Don't wish to call? You can e-mail us at:

800-326-7114  
[support@linksys.com](mailto:support@linksys.com)

If any Linksys product proves defective during its warranty period, you can call the Linksys Return Merchandise Authorization department for obtaining a Return Authorization Number at:  
(Details on Warranty and RMA issues can be found in the Warranty Information section in this Guide.)

949-823-3000